

G S M D O O R I N T E R C O M

GSM-VarioBell 4G



User manual v 1.2

Basic technical parameters:

Power supply:	12 (9-24) V AC/DC, 500mA (basic module) (optionally integrated ACU 2000mAh for approx. 35h of operation)
GSM 2G bands	3,8 (for EU)
GSM 4G bands	1,3,7,8,20,28A (for EU)
dimension:	modular system – via table
buttons:	1 or 2 in basic solution. Possibility extend up to 87 buttons + keypad (for every button max. 7 phone numbers dialed progressively)
relay:	2x relay with switching contact
Input:	0/5 V

Basic features:

GSM-Vario Bell is useful for different installation even for emergency communication.

You just insert SIM card and connect power supply, eventually connect el. lock. For its operation is used GSM network – so you don't need any telephone line or other cables.

- Basic module (VBG) with one or two buttons, eventually no buttons. Possibility to expand by extending modules (VBD) up to 87 buttons. Under each button you can program up to 7 phone numbers which are after button press progressively dialed.
- Keypad module for: dialing memory numbers (memory limited by SIM card capacity), direct dialing of phone number from keypad and inserting codes for relays activation (codes capacity again limited by SIM card only)
- 2 independent, remotely controlled switching relays with different ways of activation (activation by ringing or by code during call, by button press, by code from keypad etc...)

- 1 input for connection for example alarm (alerting by SMS) or for control of gate(door) opening (beeps during call) etc.
- Voice signaling of different events (for example. „ Wait please “ , „Open “ , etc.
- SMS sending with date, time and numbers list from which was relay activated by ringing; date and time and code when relay is activated by keypad code.

Function:

Hands free GSM phone – with preprogrammed phone numbers under each button (Buttons on basic module are marked ABUTTON and BBUTTON, buttons on extended modules B1 to B85).

1. **Outgoing call:** After button press is dialed first number from saved list of numbers. The numbers are saved under names ABUTTON1 to ABUTTON7 – it means first number under name ABUTTON1. When called party is busy or not available then automatically second number under name ABUTTON2 is dialed etc. When called party picks up the call the connection is established and next numbers are not dial (the same valid for other buttons – on extended modules are marked B1-1, B1-2.... to B85-7). Waiting time for call pick up by called party is adjustable.
2. **Incoming call:** up settings will be incoming call picked up either for all calls or for saved numbers on SIM card only (connection for saved numbers only). GSM-VARIO BELL might also reject incoming calls (see later in relay function).

2 remotely controlled switching relay. Each can be controlled up settings by different ways:

1. **By ringing** – incoming call is rejected (confirmation of command accept) and simultaneously is activated for preprogrammed time selected relay. The call is rejected /relay activated according setting either:

- a. **From numbers saved** in phone book on the SIM card **only**
 - b. **From any telephone number.**
2. **By code** –
 - during voice communication (incoming as same as outgoing call). The 1-digit code by DTMF might be dialed by called party for relay activation (for preprogrammed time). For each relay you can program different code.
 - When keypad module is connected it is possible selected relay (not during call!) activate by code from keypad. The activation might be limited also by date, time, day of the week, access numbers, etc.
 - For relay activation by code (opening) might be setup sending SMS with date, time and number (or code) of opening
 3. **By SMS** – you can remotely switch ON/OFF selected relay or activate relay for certain time mention in SMS. Relays might be controlled only from preprogrammed numbers at GSM-VB SIM card.
 4. **Camera mode** – selected relay is ON by picking up the call and it is OFF by hanging up the call.
 5. **Lighting mode** – selected relay is ON by picking up the call and it stays ON for preprogrammed time after hang up.
 6. **Button mode** – selected relay is ON after button press and stays ON for preprogrammed time.

1 programable input:

1. **SMS sending** „ALARM ON“ to preprogrammed number when input is short circuit against ground. SMS „ALARM OFF“ to next preprogrammed number when input is disconnected. It might be programmed 1 number only (ON or OFF). Then is send 1 SMS only up selected status.
2. **opening detection.** When input is activated during call (for example by gate (door) opening) the GSM –Vario

Bell generates into a call short beep for time of input activation.

Voice signaling of individual states.. Various device states are signaled by voice (language adjustable). Voice signaling is audible only on one (relevant) side – e.g. during a call the message “Call will be terminated” is only heard on the other station’s side – the other station can extend the call.

Sets

Basic module VBG-xx is main unit. Might be in 3 versions:

VBG-00 no button



VBG-01 with 1 button



VBG-02 with 2 buttons



Button module VBDx-mod:

VBD5-mod with 5 buttons

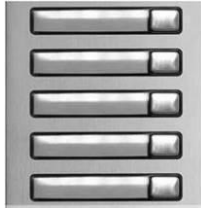

VBD10-mod with 10 buttons

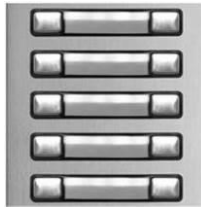

Buttons order numbering is setup by DIP switch on each module (viz. follow).

Keypad module VBDKey

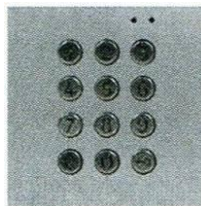

Keypad connection is not necessary to setup and it does not depend on the position where it is connected (see following pages).

Mechanical parts

For easier explanation we show mechanical parts for 1, 2 and 3 modules. In one column are max 3 modules. The big set contents max 3 columns (9 modules). For even bigger sets you can put 9 modules set over or next each other.

Mounting box for flush mounting:

Mounting box-1



Mounting box-2



Mounting box-3



Fixing and covering frame – for flush and surface mounting



For 1 module



for 2 modules

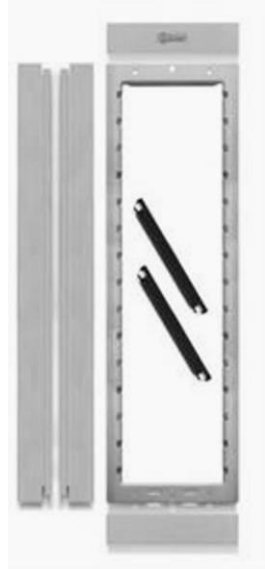

for 3 modules

design frame – flush mounting only

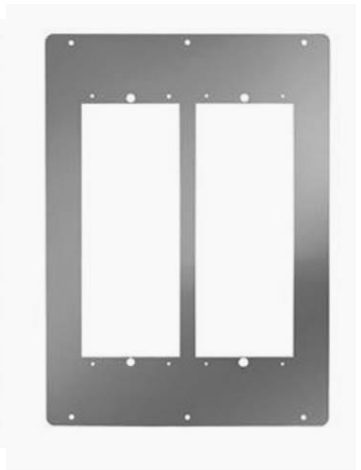

Frame-1
Frame-3
3 x 2

Frame-2
Frame -

roofing shield – flush mounting only



Shield-1



Shield-2



Shield -2 x 2

SMB – surface mounting box – surface mounting only (fixing frames are extra)



SMB-1



SMB-2



SMB-3

Control elements and connection

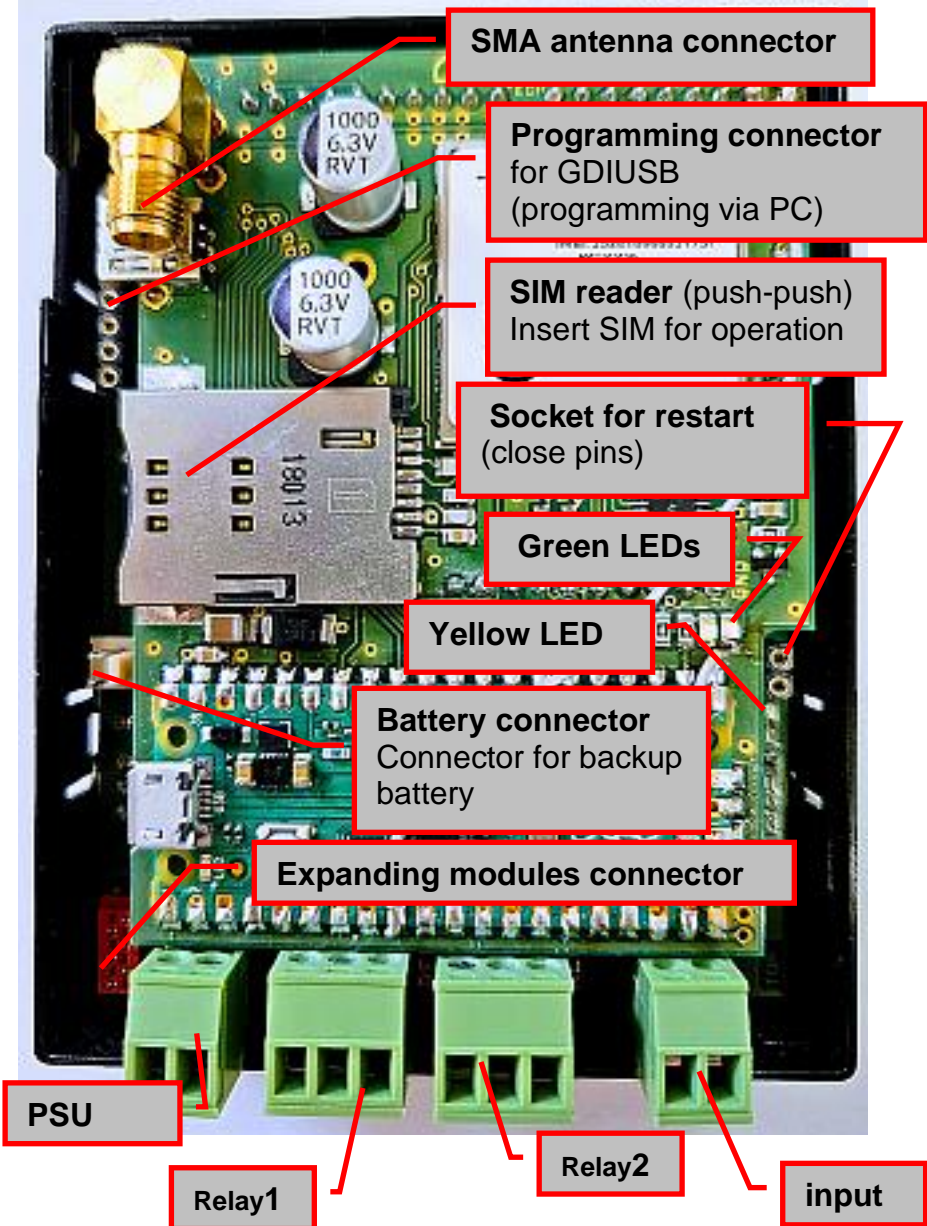

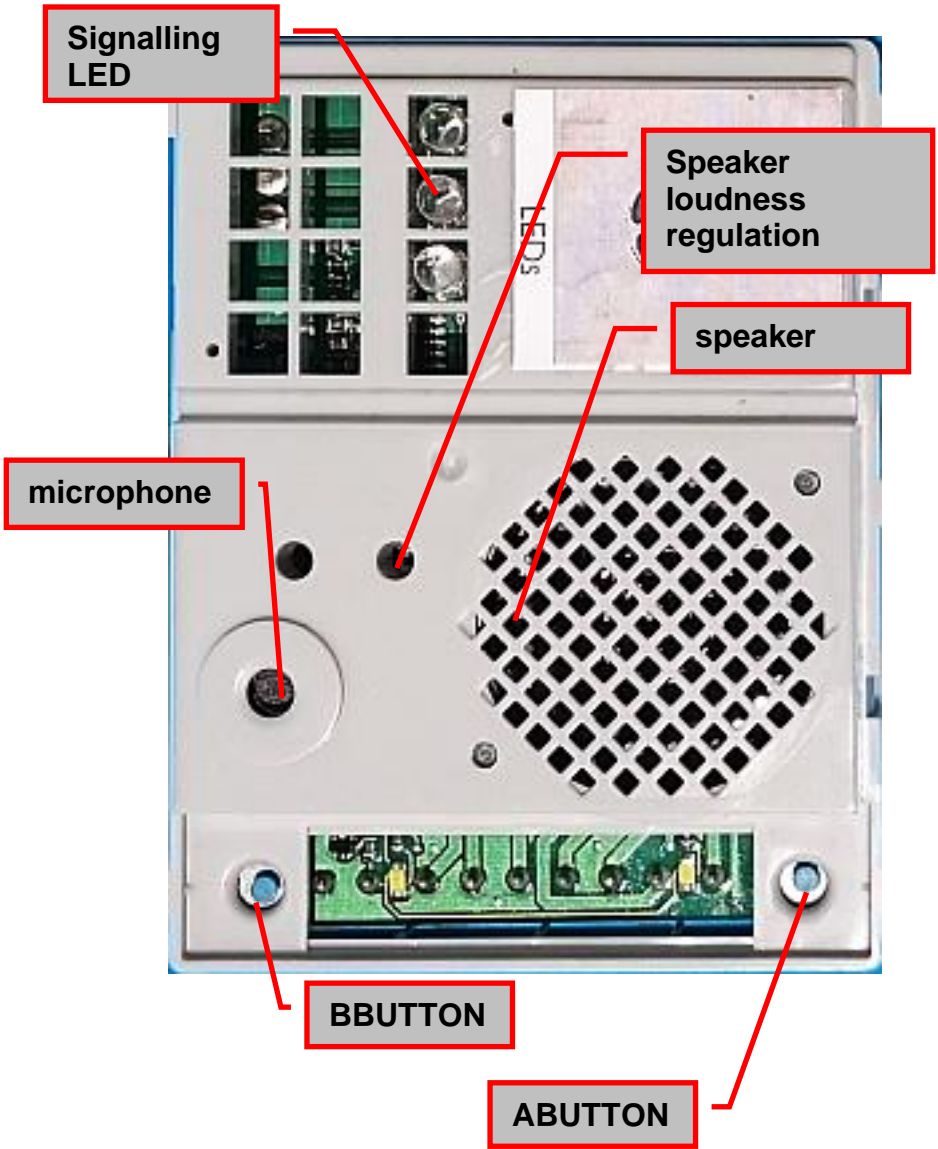

Examples of relays connection

1. Basic connection - 2 electrical locks and possibility control 2 doors
2. 2x PSU – possibility to use 2x PSU independently. First for GSM-VB and second for electrical locks.
3. Activation of external camera or light.
4. Combination of electrical lock and external bell.

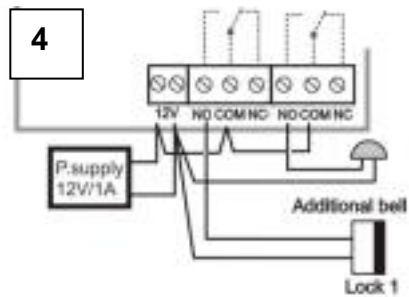
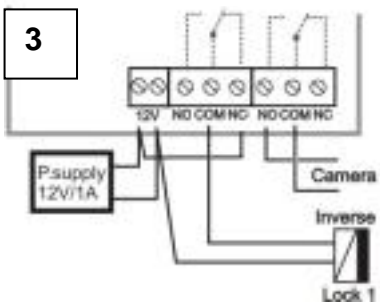
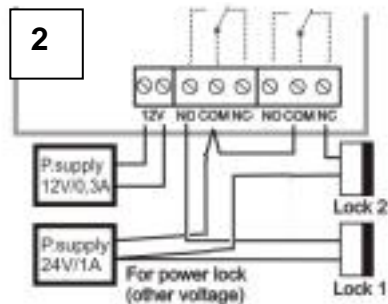
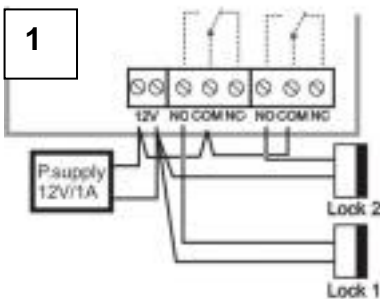

CAUTION! You must not switch direct main voltage 120V or 230V in any case!!! The control electrical appliance you have to use contactor. With the installation, please contact relevant specialist.

Connection of extending modules VBD10(5)-mod

Buttons extending modules are **VBD10-mod** with 10 buttons and **VBD5-mod** with 5 buttons.

Buttons numbering will be explained further but it is done on each button module by DIP switch (6).

PCB board with components VBDx-mod is connected to button module by screw terminal only (5) and via 3 wire cable (4).

Connection between modules is provide by flat cables K1. (1) is connection to previous module, (2) is connection of following button module, (3) is connection between button modules (still the same flat cable K1)

Connector (7) one of the modules is used for connection to basic module VBG-xx (to connector for expanding modules).

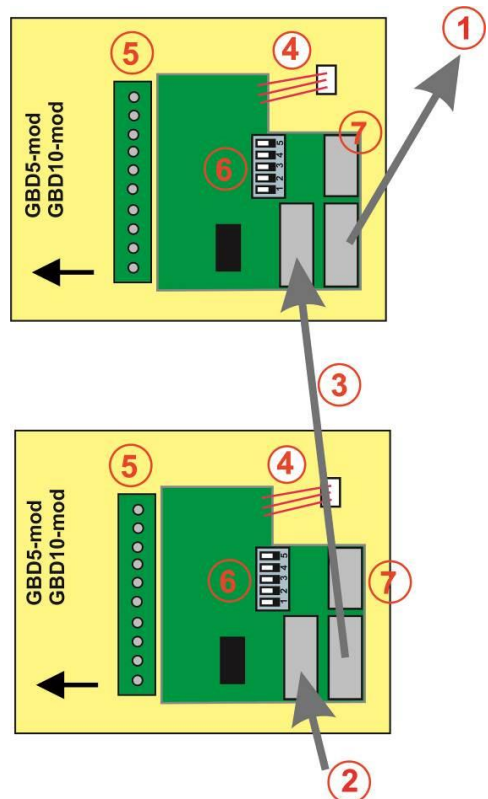

Connection K2 cable to VBG-xx module



**K2 cable (cable with red connector)
ATTENTION! Key of the connector (protrusion) toward the bottom edge connector.**



K2 connection to VBDx module

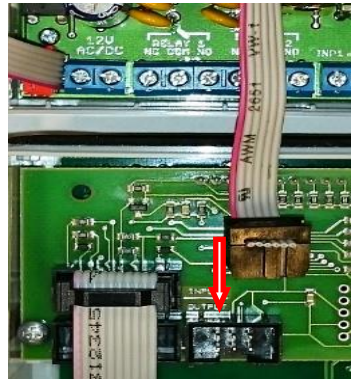

Example of connection VBD10-mod and VBDKey

Connection of each extending modules is done by flat cable K1. Nearest extending module to basic module is connected by cable K2.

Modules' numbering is setup by DIP switches (6) of each module. It not depends on connection order of each module but on DIP switch setting. When you use more modules with same DIP switch setting then buttons of those modules will have same numbers and – will be double/triple (according number of same DIP switch setting modules).

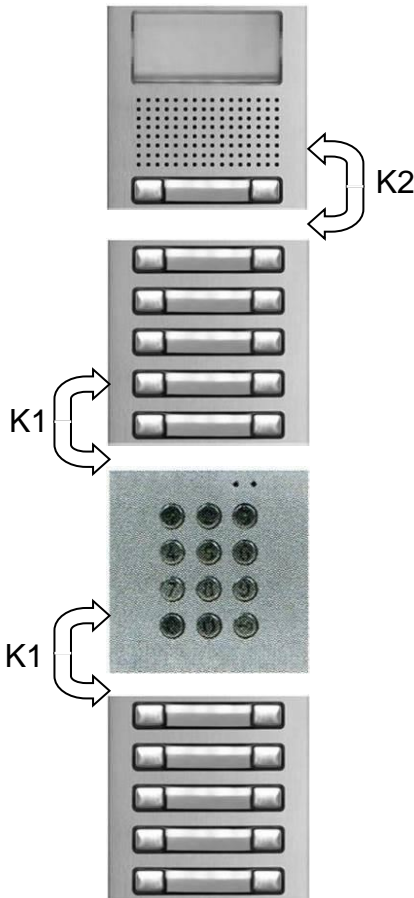

Buttons numbering

Expansion modules buttons' numbering **depends on the DIP switch setting only**. The button's name is always described by alphabetic B (button), button number (via button numbering) and after the dash by order marking of the phone number assigned to the button. For example:

B1-1 is a mark of the phone number for the button 1 which will be dialed as the first one in order (immediately after pressing the button)

B1-2 is mark of phone number for button 1 which will be dialed when the number B1-1 will be busy, not reachable or the call will not be accepted.

Please note that the buttons of the basic/main module are marked ABUTTON (the right button) and BBUTTON (the left button) after which follows again order in dialing. For example: ABUTTON1 is a mark of a phone number for the button 1 of the basic module which will be dialed as the first in order (immediately after pressing the button).

DIP switch (6) setting on the buttons' module.

each DIP switch positions have following sense:

DIP 1 – 4 = setting of previous buttons number of extending modules

DIP 5 = itself module setting (if the front panel has 5 or 10 buttons)

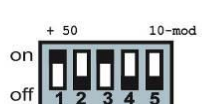
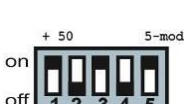
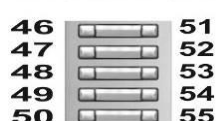
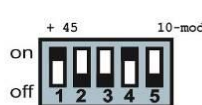
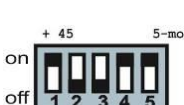
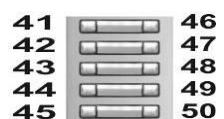
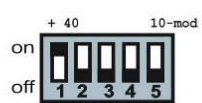
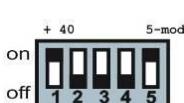
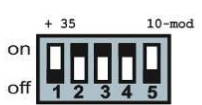
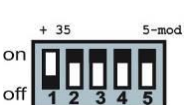
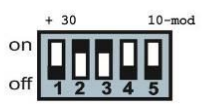
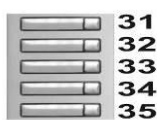
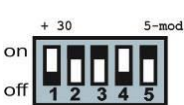
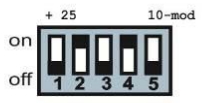
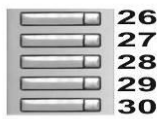
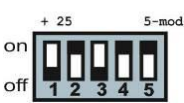
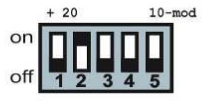
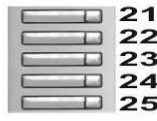
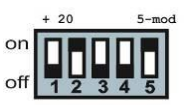
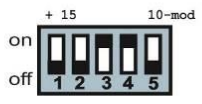
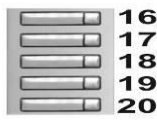
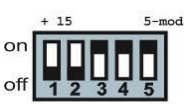
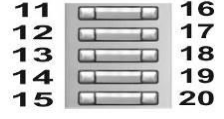
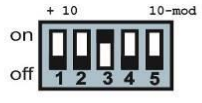
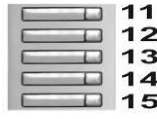
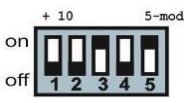
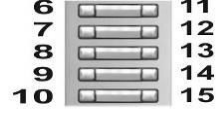
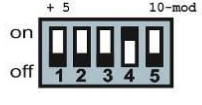
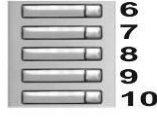
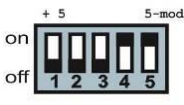
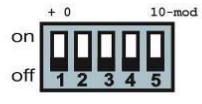
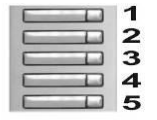
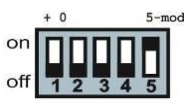

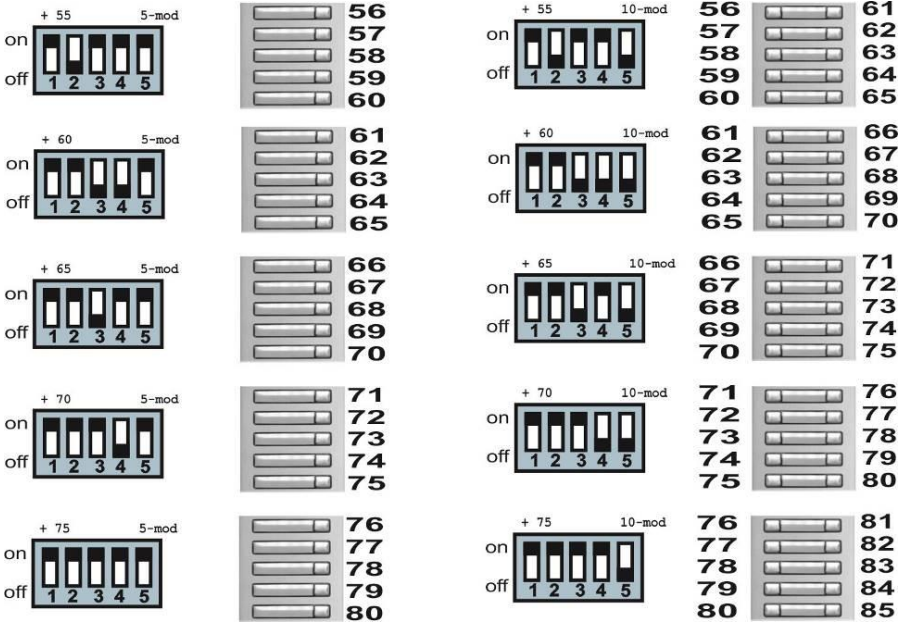

The numbering of the modules is shown in the figure. On the left are the modules with 5 buttons VBD5-mod and on the right are the modules with 10 buttons VBD10-mod. The combination of DIP switches with the corresponding settings is always shown to the left of the module illustration.

Keypad VBDKey connection

Keypad module is connected by the same flat cable as button modules VBD10(5)-mod

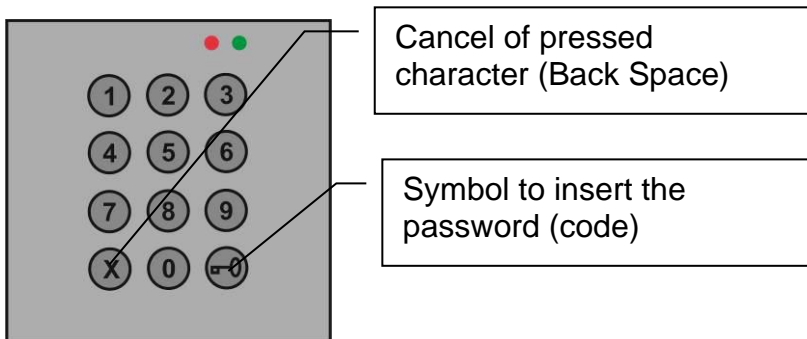

Dial or memory number is performed by progressive pressing of number buttons. To insert password for door opening you have to press first button with key symbol. To cancel just inserted number press X (Back Space).

- Direct numbers dialing – on the keypad you dial numbers like on the phone (max. 24 characters)
- Dial from door phone memory – you dial just number code on keypad = memory address (max 15 characters). There is saved up to 7 phone numbers for progressive dialing (similar as for buttons). Memory mark is always M after follow number code of memory (you dial on keypad) then dash with order number. For example, M1234-1 is marking of first phone number which will be dialed after pressing memory 1234 from keypad.

When you connect two keypads into system then functionality will be the same.

Basic module signaling on the front panel

mechanical front panel allows in basic module window LED signaling of door phone status. This signaling follow requirement of handicap law.

Bell symbol (red) – ringing during reaching call party

Handset symbol (blue) – call picked up (speech)

Open door symbol (green) – various relay is activated (door opening)

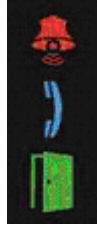

Installation

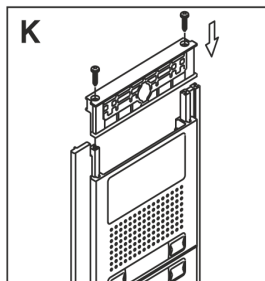
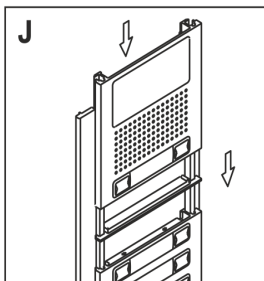
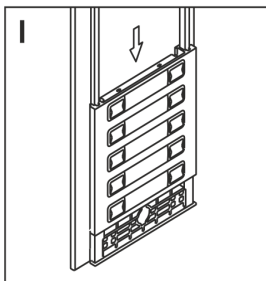
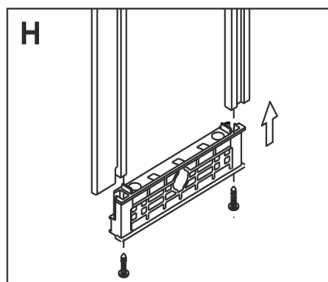
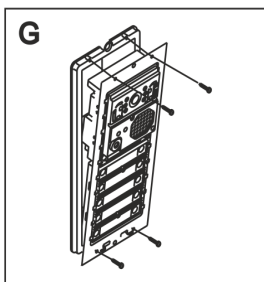
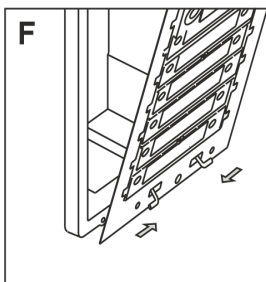
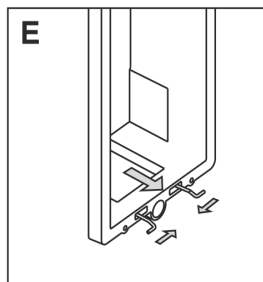
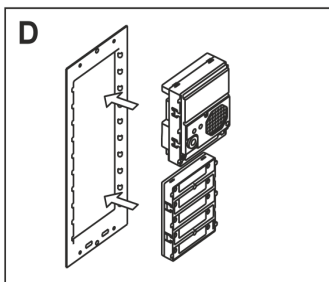
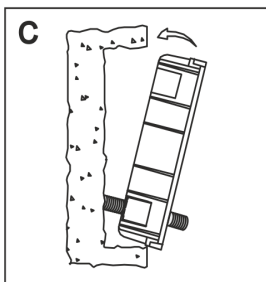
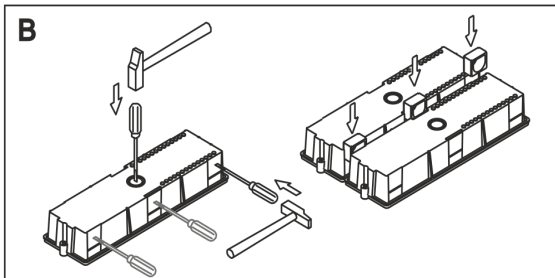
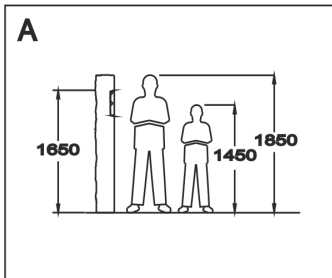

Mounting process:

- A. Preparation of mounting holes in the wall – recommended height is about 160cm from ground. Dimension of holes depends on number of modules and here we mention dimensions for 1,2 and 3 modules (basic mounting boxes). The bigger sets are completed from those boxes by their combination (under or next each other).

Modules	1	2	3
Height mm	140	257	374
Width mm	125	125	125
Depth mm	56	56	56

- B. Preparation of mounting box for cable and mutual connection of mounting boxes
- C. Mounting box fixing into hole in the wall
- D. Inserting of each module into the fixing frame
- E. Inserting of spring to bottom part of mounting box
- F. Inserting of fixing frame into spring in mounting box
- G. Installing of fixing frame to mounting box by 4 screws (supplied)
- H. Completing of design frame – firstly screw up side rails with bottom part
- I. Into design frame insert front panels of each module
- J. Last module (module on top) is slide into design frame
- K. At the end screw up top part of design frame into side rails
- L. This complete as set is on picture (H+I+J+K) for further set into next mounting box
- M. Last step is put covers on design frame

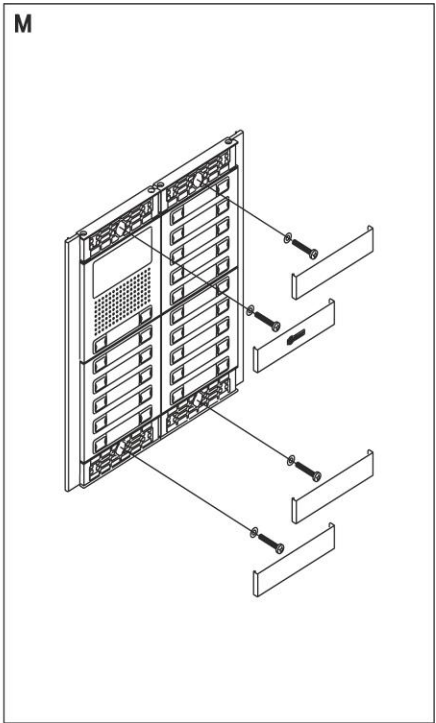
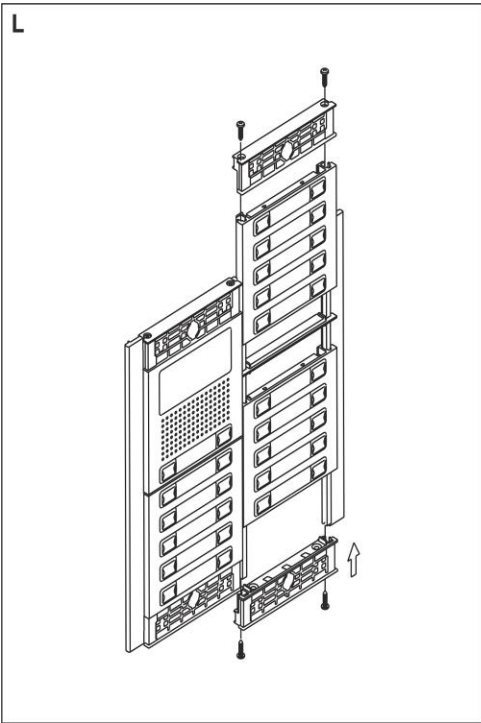

Start operation

1. connect antenna and insert the SIM

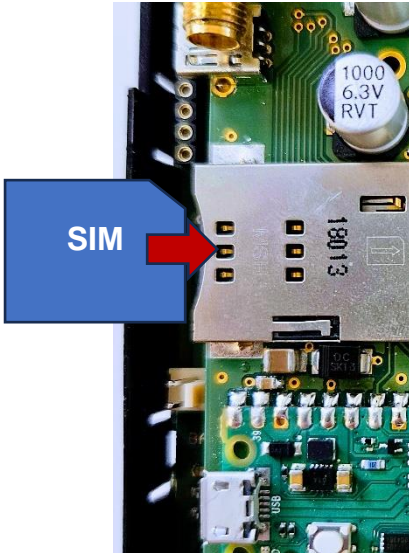

We recommend use SIM without PIN. When is not possible, setup PIN1234.

Note: All programmed parameters are saved on SIM card. The SIM you can insert to GSM-VB already preprogrammed or setup GSM-VB after switching ON via bellow described procedures.

When you want to use call reject (ringing) then ask GSM operator to deactivate your voice mail on used SIM card!

SIM card pre-programming

1. The SIM card, which you will use in the GSM-VB, needs to be prepared. Insert it into any mobile phone you have available.
2. If the SIM card has a PIN code enabled, then cancel it/disable it (or setup the PIN to 1234)
3. If you wish to setup the GSM-VB remotely via text messages, save on the SIM card a phone number from which you wish to make a configuration. Save it under a name ADMIN1.
4. Save a phone number on the SIM card which should be dialed after pressing the right button (A) under name „ABUTTON1“.
5. When you have the GSM-VB with 2 buttons on the basic module only, save on the SIM card also a phone number which will be dialed after pressing the left button (B) under name „BBUTTON1“.
6. If you wish automatic progressive dialing of next numbers in order (when the first number is busy or not reachable), save appropriate numbers under names ABUTTON2 to 7 and BBUTTON2 to 7.
7. Similarly, you can program further buttons and set all other parameters (via the table at the end of this manual)

Saving phone numbers on the SIM card is different on different types of mobile phones. **Please make sure that saved phone numbers are saved on the SIM card and not into the internal mobile phone´s memory!**

2. Switch ON GSM-VB

Switch on the unit only after you have connected all required wires (relays, locks, etc.) Be careful when connection the antenna. Only at the end connect the power supply adapter. After a while, a tone will be heard and then the left green LED and yellow LED will light up (see picture on page 9). After a while, the button lighting will come on. The GSM-VB signals the progress of the device start-up (login to GSM, loading of voice messages, etc.) with different tones and the lighting (blinking) of the LEDs described above. The start-up process is terminated (after approx. 90 seconds) by the voice message "Device in standby mode".

When you have preprogrammed the SIM card, you can try the first connection – press a button. The GSM-VB must dial the programmed number which has been assigned to a specific button. When the SIM card is not programmed, first of all program it (via later described methods) and only then try a connection (the buttons do not have any assigned, any programmed numbers – that means the GSM-VB cannot call anywhere). After establishing a call, you can adjust the speaker's loudness. Close the cover and assemble the unit.

3. program the GSM-VB parameters

After switching on, you can program GSM-VB parameters in 2 ways. With SMS text messages or with a configuration program via a USB port of your Windows computer.

Attention: Always save phone numbers of participants in international format (+.....)

A) Parameters setting by SMS.

Due security reasons, the parameters of the GSM-VB are possible to setup from numbers saved on the SIM card under names ADMIN1 to ADMIN9 only.

SMS are always written in CAPITAL (BIG) LETTERS!

Each SMS elements are always split by space (words). First word is always command. Further word (s) is one or more parameters.

Example: **INIT ADMIN1 +420123456789**

All commands are in an appropriate table in this manual further.

1. During the first setup when the SIM card doesn't contain any ADMINx name, it is necessary to write such a number to the SIM card via an SMS message using the INIT command. You can send this SMS message from any GSM number. When the SIM card already contains a number under the name ADMINx, then the command will be ignored.
2. When you need to control the relay eventually by setup GSM-VB from next ADMIN numbers perform the following: from a mobile phone with ADMINx number send progressively SMS to GSM-VB with numbers of next ADMINx in the SMS format: WRITE ADMIN2 +420xxxxxxxx (WRITE ADMIN3... etc.)

3. From a mobile phone with numbers ADMINx send progressively SMS to GSM-VB with numbers which should be dialed after pressing the button, SMS format: WRITE ABUTTON1 +420xxxxxxxx (WRITE BBUTTON1... etc.)
4. Based on your needs, send next SMS with other parameters for opening by ringing, SMS alarm sending, etc.
5. Setup parameters GSM-VB (via table). Parameters can be setup individually for each parameter with an appropriate SMS. When you need to setup more parameters simultaneously, we recommend using SMS for batch setting. Initially by the SMS „READ PAR“ read the current setting to your mobile phone.
6. By editor of SMS messages change at received SMS word READ to WRITE as well as adjust parameters based on your needs. Such adjusted SMS send back to GSM-VB as a reply. The parameters will be setup.

Attention: If you want to use the same phone number as ADMINx and for call after pressing a button or selecting a code from the keyboard, this number must first be saved as ADMINx! If GSM-VB, after receiving an SMS and searching for the assignment of the phone number from which the SMS was sent, first encounters a label other than ADMINx, it ignores the SMS!

B) Parameters setting by PC and program GSMVBellset

1. Connect the Mini USB cable to the PC and to the programming module (GDI USB) – green LED must light on at the module. The USB driver may be automatically installed upon first use (the PC must be connected to the Internet).
2. Insert connector of programming module into GSM-VB (see picture). On programming module must light on red LED (It is flashing same way like yellow LED on GSM-VB)

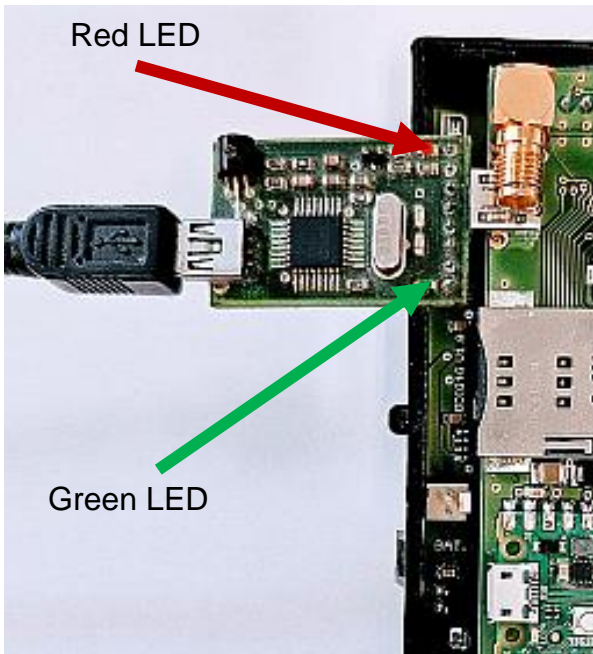

3. Run program GSMVBellset and setup appropriate COM port - Attention: The program must be at least version 5.0
4. Program controls GSM-VB connection. After that display GSM signal strength and voltage on GDI (back up ACU). Now you can program.

Mode monitor

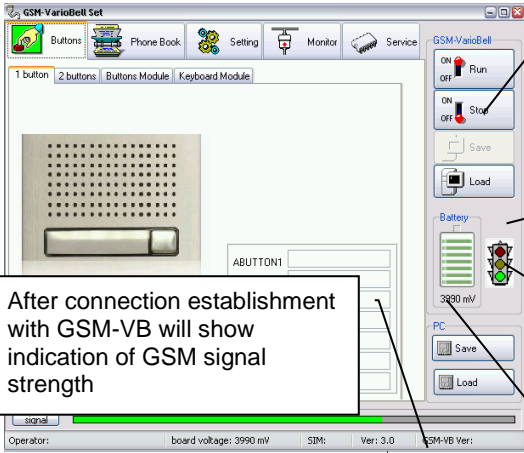

To setup parameters stop program running in GSM-VB.
Do not press to operation monitor! You stop GSM-VB operation!

Indication of serial line operation

Status semaphore:
green – Standby mode
rot – Programming mode

After connection establishment with GSM-VB will show indication of voltage in GSM-VB

After connection establishment with GSM-VB will show indication of GSM signal strength

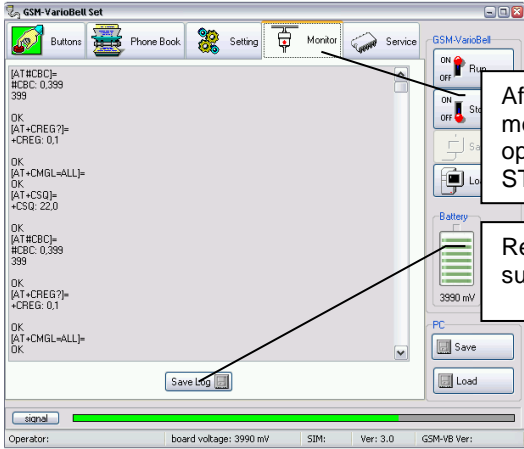

After click to monitor button is possible monitor operation in GSM-VB (when operation is not stopped by button STOP)

Report saving from monitor to file (for support purposes – report sending)

Waiting for GSM-VB feedback

Mode programming



After button STOP pressing program sends to GSM-VB command to STOP and wait for GSM-VB feedback (see picture). **GSM-VB signals the switch to programming mode with an appropriate voice message** and program via status semaphore.

folder Buttons

It is design to program phone numbers under each button and for cooperation with keypad (insert phone numbers to memory and insert codes)

One button folder

Field to program up to 7 phone numbers for one button

Folder for two buttons

Field to program up to 7 phone numbers for right button

Saving of all programmed numbers and parameters to GSM-VB

Reading of all programmed numbers and parameters from GSM-VB

Saving of all programmed numbers and parameters to PC

Reading of all programmed numbers and parameters from PC

Program version and fw version of GSM-VB

SIM card capacity

GSM operator where is GSM-VB registered

Field to program up to 7 phone numbers for left button

The screenshot shows the GSM-VarioBell Set software interface. It features a main window with several tabs: "Buttons", "Phone Book", and "Settings". The "Buttons" tab is active, showing a list of button memories on the left and a configuration panel on the right. The list on the left contains entries like "23:B1-1[123456789]", "32:B1-2[7987654321]", and "39:B1-3[24681234]". The configuration panel on the right shows fields for "Position", "Memo", and "Phone Number", along with buttons for "Add Button", "Write Button", and "Del Button". A "Buttons Detect" checkbox is also present. At the bottom, a status bar shows "Operator: *1 Mobile CZ", "board voltage: 3990 mV", "SIM: 250", "Ver: 3.0", and "GSM-VB Ver: 136".

Folder for expanding button modules

List of all memories and phone numbers of each button saved on SIM card. List is arranged according buttons.

List of all memories and phone numbers for button selected from list on the right (by click on various memory of this button)

ON/OFF function „Buttons Detect”. When is GSM-VB switched ON with active function “Buttons Detect” then is not dial saved number under button on expanding module when is pressed but on the SIM is saved appropriate name for first button position. Instead of phone number is saved pause (“P”).

Erase selected memory button from SIM

By grey color is marked selected memory

Phone number

Order of phone number in dialing process

number (name) of button

Position on SIM

Result of function „Buttons Detect“ for expanding module with setup buttons from 1 to 10. Button B1 is busy already by 3 progressively dialing phone numbers.

Edit of selected number (insert number instead of „P“)

Select button to edit

List of edit with all appropriate phone numbers saved on SIM for this button (here just one record - P)

After click to selected memory (here just one – B2-1) will occur in edit fields each element of record (via description of previous page)

Order in dialing

Button number

Button name

Phone number - instead „P“ write phone number which should be dial.

Record of memory button to SIM

Adding of memory (next dialing number in order for button from previous example)

Clicking the button will increment the number in the call order. Notice that there is no longer any greying – there is no editing, a new phone number is being added

To field „Phone Number“ is copy phone number from previous position (for selected button) – here „P“. Continue like in previous example.

Adding of button (function for automatic button detect wasn't used)

Process similar like in previous example (click on „Add Button“). BUT is necessary:

1. setup required button number
2. setup required order of phone number in dialing

Those parameters in previous example (adding number to order for preselected button) have been created automatically.

.... 24:B2-1[P]

Position 1 Memo 22 (B22-1)

Phone Number 123456789

Add Button Write Button Del Button

Erase of selected memory from SIM
Function is the same like for erasing in main list. The selection is done in list of selected number

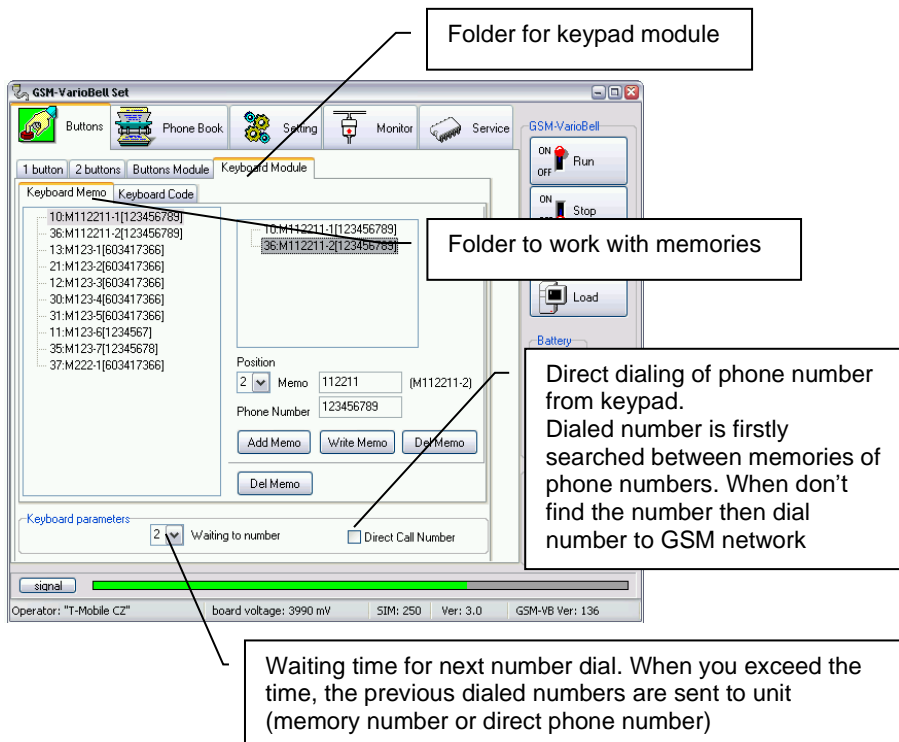

Work with phone numbers memories saved under selected code is the same like work with buttons. Instead of marking B (button) is used marking M (memory). For example: M1234-1 is marking of memory where is saved phone number which is dialed as first after dialing code 1234 on keypad.

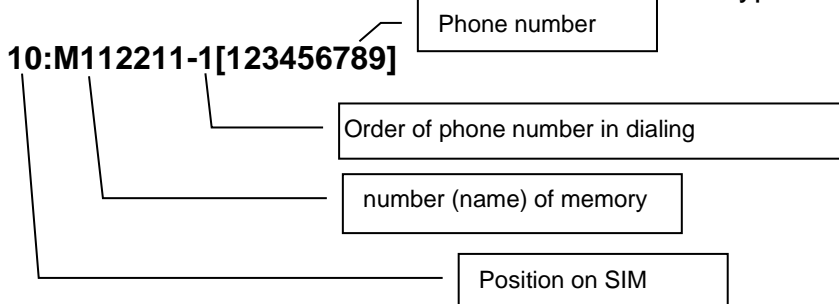

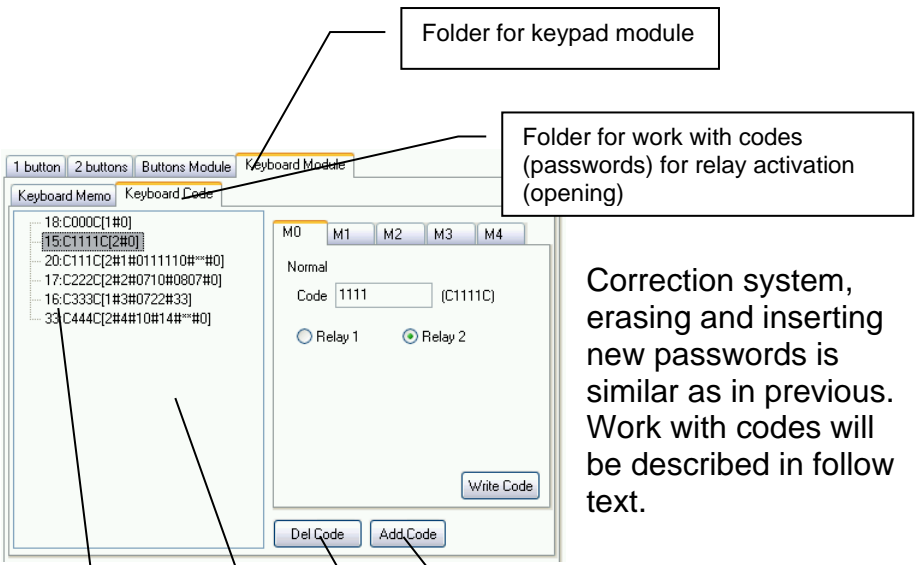

Folder for keypad module

Folder for work with codes (passwords) for relay activation (opening)

Correction system, erasing and inserting new passwords is similar as in previous. Work with codes will be described in follow text.

Adding code

Erasing selected code

List of codes saved on SIM

Position on SIM

33:C444C[2#4#10#14##0]**

Code parametres – via description at command table

Name under which is code (444) saved on SIM

Work with codes (passwords)

5 modes of codes (M0-M4)

After code selection from list will be automatically setup appropriate folder. When you insert a new password, you have to select appropriate folder (according required code features) manually.

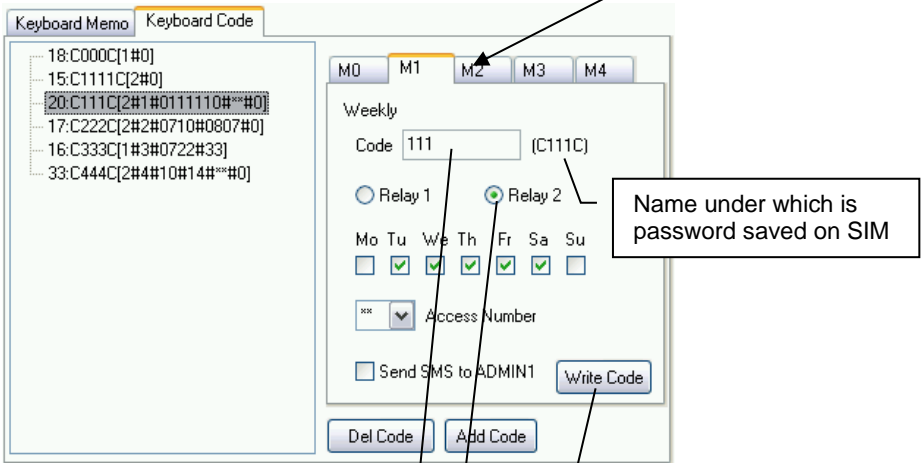

Every folder has:

Field to insert number of code which is then dialed on keypad

Relay selection which will be activated by code.

Button to save password to SIM

M0

The simplest mode – selected relay will close after inserted code from keypad for preprogrammed time. (via parameter time of relay activation further in manual)

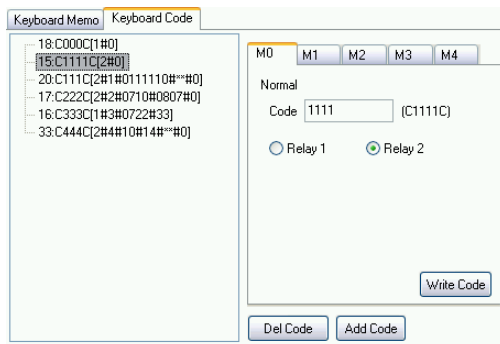

M1

After code insert the relay close in preprogrammed days of week only. The GSM-VB might also calculate number of used codes and when number exceed preprogrammed value (for example number of prepaid entrances) the code is refused. Code using might be announced by sending SMS with date, time and used codes.

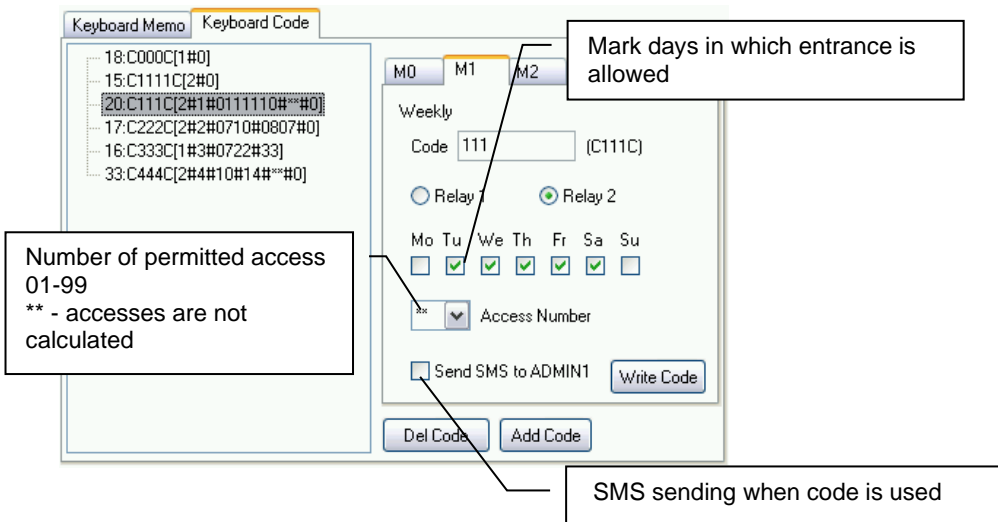

M2

After inserting the code relay is activated in range of setup dates (included). Code using might be announced by sending SMS with date, time and used codes

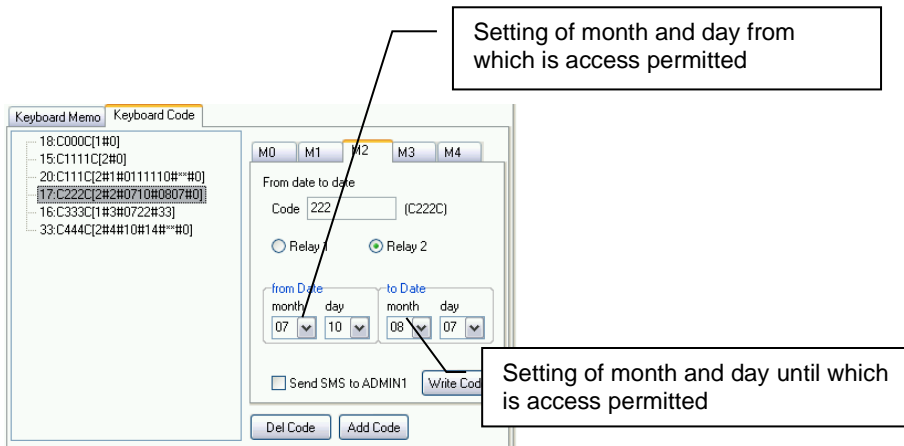

M3

After code insert the relay is activated from setup date. The GSM-VB might also calculate number of used codes and when number exceed preprogrammed value (for example number of

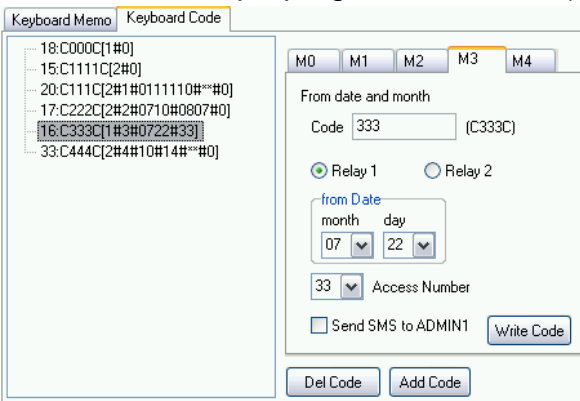

prepaid entrances) the code is refused. Code using might be announced by sending SMS with date, time and used codes.

M4

After inserting the code relay is activated in range of setup hours (working time). The GSM-VB might also calculate number of used codes and when number exceed preprogrammed value (for example number of prepaid entrances) the code is refused. Code using might be announced by sending SMS with date, time and used codes.

Setting of hours from which is access permitted

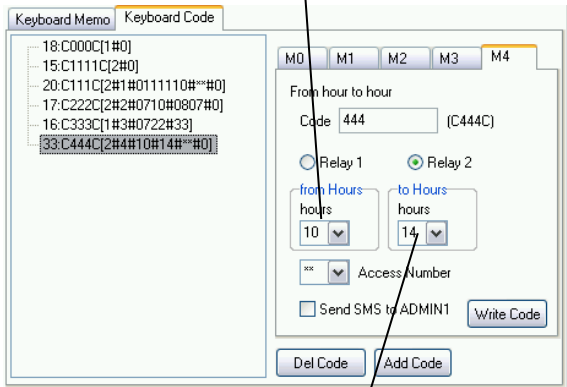

Setting of hours until which is access permitted

Caution: To use relay activating by codes (passwords) do not forget to setup appropriate relay mode (via folder relay).

Folder Phone Book

Phone book of authorized numbers to activate relay by ringing and automatic calls receiving.

The screenshot shows the 'Phone Book' tab in the GSM-VarioBell software. A table lists entries with 'Name' and 'Phone' columns. Callouts point to the 'Name' and 'Phone' headers. On the right, buttons for 'Insert Line', 'Delete Line', and 'Find' are shown. Further right, a 'Find Name' input field with a 'Find' button is highlighted. On the far right, a vertical toolbar contains buttons for 'Run', 'Stop', 'Save', and 'Load', with callouts for 'Add row on top of row with cursor' and 'Erase row with cursor'. A 'Battery' status indicator shows 3990 mV. At the bottom, a status bar displays 'Operator: T-Mobile C2', 'board voltage: 3990 mV', 'SIM: 250', 'Ver: 3.0', and 'GSM-VB Ver: 136'.

Name	Phone
PARAMGDI	4#4#0#0#1#5#0#3
PARAMRL1	5#1#03#0
PARAMRL2	6#1#05#1
M112211-1	123456789
M123-6	1234567
C1111C	2#0
C333C	1#3#0722#33
C222C	2#2#0710#0807#0
C000C	1#0
B10-1	P
C111C	2#1#0111110#""#0
B6-1	P
B1-1	123456789
B2-1	P
B3-1	P
B4-1	P
B5-1	P
B9-1	P
B7-1	P

Folder Setting – parameters setting

The screenshot shows the 'GSM-VarioBell Set' software interface. The 'Setting' tab is active, displaying various call-related parameters. Annotations with callout boxes point to specific settings:

- Folder Calls**: Points to the 'Calls' tab in the top navigation bar.
- Setting loudness of speaker**: Points to the 'Volume Spk' slider.
- Setting loudnes of microphone**: Points to the 'Volume Mic' slider.
- Way of calls receiving:**
 - do not receive (open by ringing)
 - automatically pick up calls from numbers from list only
 - pick up all callsPoints to the 'Incoming Call Pick Up' section, which includes radio buttons for 'No - ringing switch', 'only from GSM', and 'All'.
- Waiting Call**
Waiting for dialing next number from list: Points to the 'Waiting Call' section, which has a dropdown menu set to '20' and the unit 'sec'.

The interface also includes a status bar at the bottom with information such as 'Operator: "T-Mobile CZ"', 'board voltage: 3990 mV', 'SIM: 250', 'Ver: 3.0', and 'GSM-VB Ver: 136'. On the right side, there are controls for 'GSM-VarioBell' (ON/OFF, Run), 'Battery' (3990 mV), and 'PC' (Save, Load).

Folder relay

Setting parametres for relay 1

Setting parametres for relay 2

Relay modes:

- camera
- light
- button
- control by SMS
- control by code or ringing

Relay control by ringing from numbers saved on SIM only

Relay control by ringing from any number

DTMF code to activate relay during call

Time of relay activation

The screenshot shows the 'Relays' tab in the 'GSM-Variobell Set' software. It displays two columns for 'Relay 1' and 'Relay 2'. Each column has radio buttons for 'camera', 'light', 'button', 'SMS switch', and 'switch'. Under 'switch', there are checkboxes for 'switch SIM ringing' and 'switch all ringing'. Below these are input fields for 'switching code' and 'switching time'. For Relay 1, the switching code is '5' and the switching time is '03'. For Relay 2, the switching code is '6' and the switching time is '05'. The 'switch SIM ringing' checkbox is checked for Relay 2. On the right side, there are buttons for 'Run', 'Stop', 'Save', and 'Load', along with a battery level indicator showing 3990 mV. The status bar at the bottom shows 'Operator: T-Mobile CZ', 'board voltage: 3990 mV', 'SIM: 250', 'Ver: 3.0', and 'GSM-VB Ver: 136'.

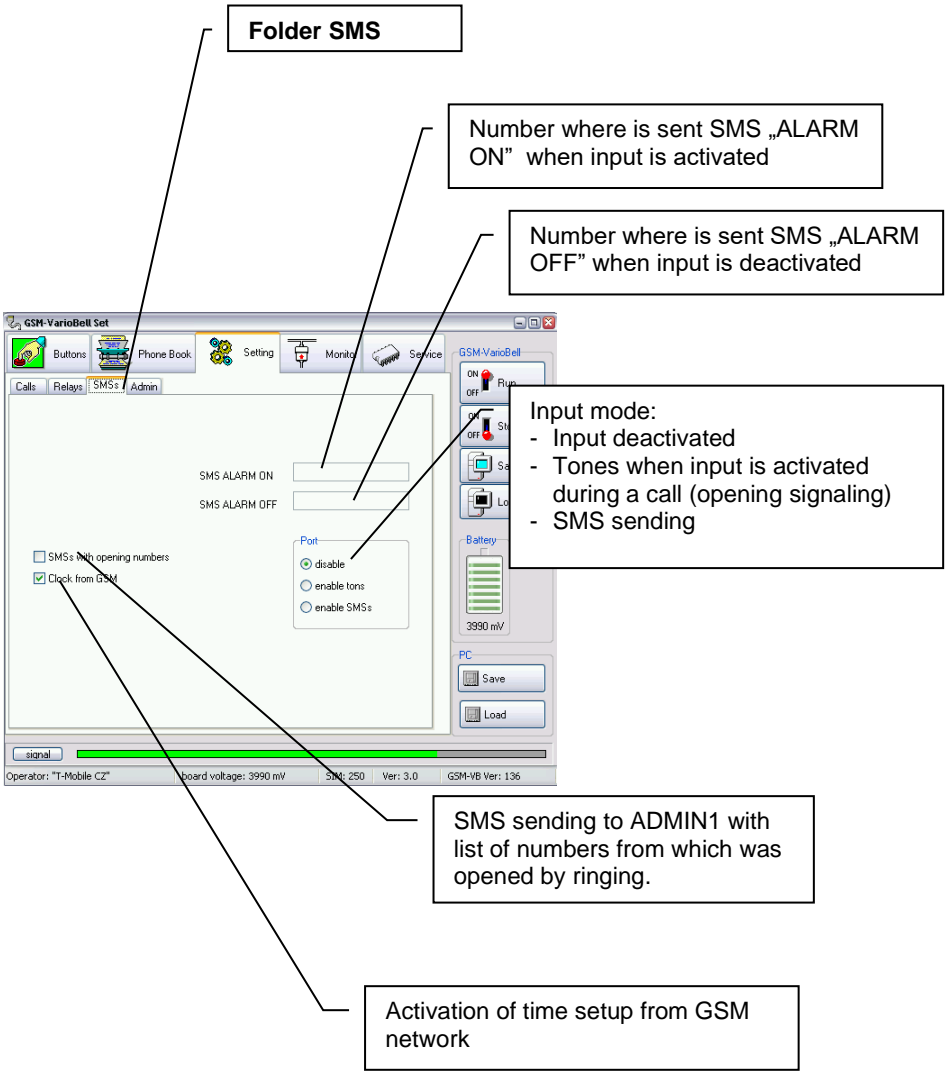

Folder ADMIN numbers setting

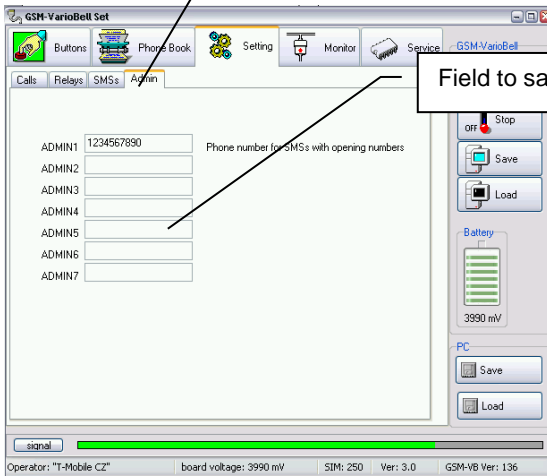

Field to save up to 7 ADMIN numbers

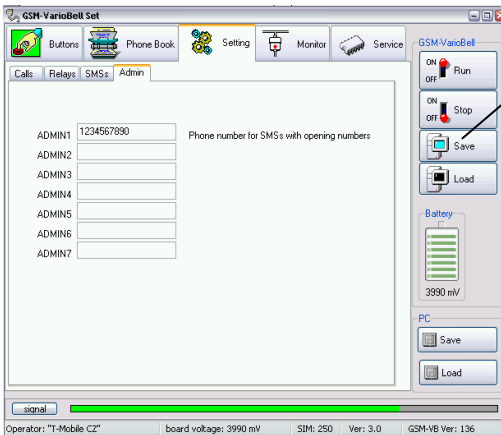

When all necessary is setup then save all by button „Save“ to GSM-VB. (when you did setup buttons ,passwords or memories in extending modules – they are saved automatically when you press button „Write...“.

Folder Service

It is intended for upgrade voice messages in GSM-VB.

ATTENTION! Improper use can cause the GSM-VB to block.

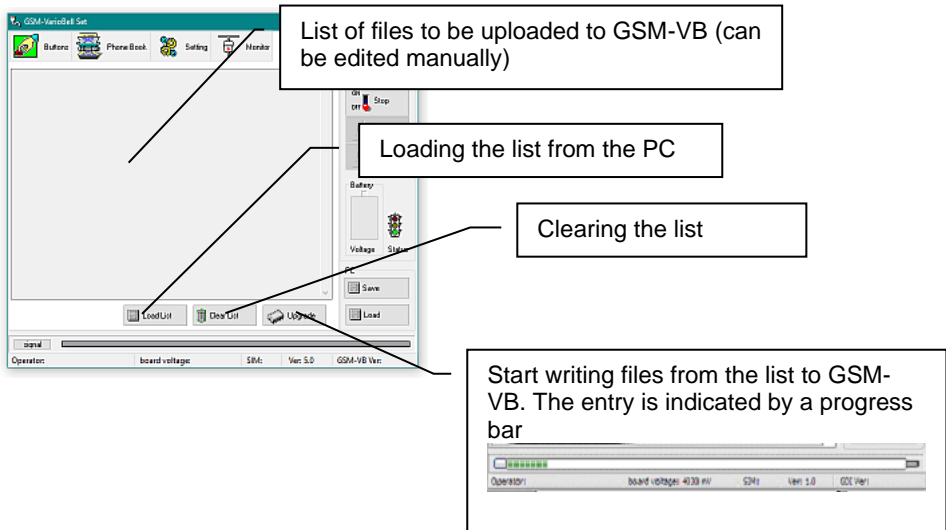

Procedure:

The message file is usually delivered in separate folders, which are zipped.

1. Unzip the zip (including the directory) into the GSM-VarioBellset directory.
2. Switch GSM-VB to programming mode
3. Use the "LoadList" button select in the following dialog a file with the ".ifo" extension in the uploaded directory (a list of files to be uploaded will appear in the window).
4. Use the "Upgrade" button to start writing to GSM-VB.
5. After successful saving (you can monitor on the "Monitor" tab), you can adjust the parameters, etc. in the appropriate tabs as needed
6. If you have made any changes, save them to GSM-VB with the "Save" button
7. Press the "Run" key to restart GSM-VB

Return from programming mode to monitor mode (restart GSM-VB)

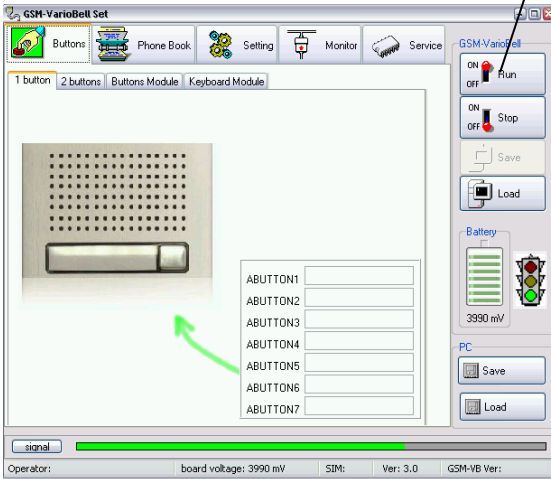

For return to monitor mode (start of GSM-VB) click on button „Run“. Program detects start of GSM-VB the same way as stop:

GSM-VB signals the return to Standby mode with the appropriate voice message, program with a green light on the status traffic light.

Table of commands for SMS

Command (SMS)		Function	Def.
SMS is possible send from ADMINx numbers only	READ STAT	GSM-VB status reading (version, operator, status of relais etc.)	
	READ PAR	Reading of all set parameters	
	READ NAME	Reading of phone number for NAME	
	CLR NAME	Erase of phone number for NAME	
	INIT ADMIN1 +420cc...c	First setting of GSM-VB – parameters possible setup from number ADMIN1 +420cc..c	
	SET REL1 ON	Relay 1 - ON	
	SET REL1 OFF	Relay 1 - OFF	
	SET REL1 ON xx	Relay 1 – ON for xx minutes (xx=00 -99)	
	SET REL2 ON	Relay 2 - ON	
	SET REL2 OFF	Relay 2 - OFF	
	SET REL2 ON xx	Relay 2 – ON for xx minutes (xx=00 -99)	
	WRITE NAME +420cc...c	Write phone number for NAME	
	WRITE PAR VOLIN:x	Write Microphone loudness [x=1-7]	4
	WRITE PAR VOLOUT:x	Write speaker loudness [x=1-7]	4
WRITE PAR INCALL:x	Processing of incoming call: x: 0 – calls refused (ringing) 1- Calls picked up from SIM only 2 – all calls picked up	0	
WRITE PAR WRCALL:x	Sending out SMS with numbers which opened the door	0	

		0 – OFF 1 - ON	
SMS is possible send from ADMINx	WRITE PAR TMGSM:x	Setup time according GSM network x: 0 – OFF 1 - ON	1
	WRITE PAR INPMOD:x	Input mode x=0 – OFF x=1 – beeps to call (indication of open) x=2 – during connection/disconnection send SMS	0
	WRITE PAR WAIT:xx	Waiting to dial next number from list xx – 10 to 90 sec (by 10)	2
5	WRITE PAR RL1COD:y	Code to activate relay1 during call y= 0-9	5
	WRITE PAR RL1MOD:x	Relay 1 modes x=0 – control by SMS x=1 – mode switch (by ringing from numbers on SIM or by code) x=2 – camera mode (close by pick up, open by hang up) x=3 – lighting mode (close by pick up-stay close for „time activation“ after hang up x=4 – close for „activation time“ after button press x=5 – extra switch mode (by ringing from any number or by code)	1
	WRITE PAR RL1TMON:yy	Activation time for relay 1 after ringing or by code activation yy seconds yy=00-99	03
5	WRITE PAR RL1RING:x	Relay 1 activation by ringing	1

	x=0 – OFF x=1 - ON	
WRITE PAR RL2COD:y	Code to activate relay 2 during call y= 0-9	6
WRITE PAR RL2MOD:x	Relay 2 modes x=0 – control by SMS x=1 – mode switch (by ringing from numbers on SIM or by code) x=2 – camera mode (close by pick up, open by hang up) x=3 – lighting mode (close by pick up-stay close for „time activation“ after hang up x=4 – close for „activation time“ after button press x=5 – extra switch mode (by ringing from any number or by code)	0
WRITE PAR RL2TMON:yy	Activation time for relay 2 after ringing or by code activation yy seconds yy=00-99	05
WRITE PAR RL2RING:x	Relay 2 activation by ringing x=0 – OFF x=1 - ON	0
WRITE PAR WAITBUF:y	Time to wait for pressing next button y sec y= 1-9	2
WRITE PAR DDIAL:x	permit/ prohibit direct dialling from keypad: x=0 – prohibit x=1 – permitted	0
WRITE ALARMON +420cc..c	Write number for SMS „ALARM ON“ (input grounding)	

	WRITE ALARMOFF +420cc.c	Write number for SMS „ALARM OFF“ (input disconnect)	
SMS can be sent from ADMINx numbers only	CAL AT+CSQ	GSM signal strength level	
	CAL AT+CPBR=x	Finding out number saved on position x	
	CAL AT+CCLK=<<time>>“	Setup time in GSM-VB to <time> format <time>= yy/MM/dd,hh:mm:ss±zz yy – year (00-99) MM – month (01-12) dd – day (01-31) hh – hours (00-23) mm – minutes (00 – 59) ss – seconds (00 – 59) ±zz – time zone (-47..+48) hours	

Types of commands:

READ – command to read parameters and phone numbers from the SIM card. It means also reading of phone numbers saved under buttons (for example READ B1-1), in memories (for example READ M1234-1), codes setting (for example READ C123C) or parameters of GSM-VB in internal format (READ PARGDI)

CLR - command to erase phone numbers from the SIM card. **CAUTION!** When you use SMS to erase numbers, you must keep in the GSM-VB at least one ADMINx number– otherwise remotely you can't program (it would be necessary to make a complete restart - initialization).

INIT – Initialization. During the first setup when the SIM card is empty – no ADMINx names are necessary to be saved. You can save such a number to the SIM card

by SMS with command INIT. SMS is possible to send from any GSM number. **When the SIM card has already at least one number under the ADMINx name, then the command is not be executed, it will be ignored.**

WRITE – command to save parameters and phone numbers to the SIM card – also phone numbers under buttons (for example WRITE B1-1 123456789), in memories (for example WRITE M1234-1 123456789), codes setting (for example WRITE C123C 2#0) or parameters GSM-VB in the internal format.

CAL - after CAL command you can put any AT command of used GSM module (for example module reset, time setting etc.). **Use of these commands requires a deeper knowledge of the system otherwise you can damage of the unit!**

Meaning of names saved in phone book

name	function
ABUTTON1	<ul style="list-style-type: none"> - this number is called by GSM-VB when button is pressed (right) - by ringing activate relay 1 and relay 2 - from this number are automatically received the calls
ABUTTON2	<ul style="list-style-type: none"> - this number is called by GSM-VB when number under button ABUTTON1 is not reachable, busy or not pick up the calls - by ringing activate relay 1 and relay 2 - from this number are automatically received the calls
ABUTTON3	<ul style="list-style-type: none"> - this number is called by GSM-VB when number under button ABUTTON2 is not reachable, busy or not pick up the calls - by ringing activate relay 1 and relay 2 - from this number are automatically received the calls
ABUTTON4	<ul style="list-style-type: none"> -- this number is called by GSM-VB when number under button ABUTTON3 is not reachable, busy or not pick up the calls - by ringing activate relay 1 and relay 2 - from this number are automatically received the calls
ABUTTON5	<ul style="list-style-type: none"> -- this number is called by GSM-VB when number under button ABUTTON4 is not reachable, busy or not pick up the calls - by ringing activate relay 1 and relay 2 - from this number are automatically received the calls
ABUTTON6	<ul style="list-style-type: none"> -- this number is called by GSM-VB when number under button ABUTTON5 is not reachable, busy or not pick up the calls - by ringing activate relay 1 and relay 2 - from this number are automatically received the calls
ABUTTON7	<ul style="list-style-type: none"> -- this number is called by GSM-VB when number under button ABUTTON6 is not reachable, busy or not pick up the calls - by ringing activate relay 1 and relay 2 - from this number are automatically received the calls

BBUTTON1	<ul style="list-style-type: none"> - this number is called by GSM-VB when button on the left is pressed (version with 2 buttons) - by ringing activate relay 1 and relay 2 - from this number are automatically received the calls
BBUTTON2	<ul style="list-style-type: none"> -this number is called by GSM-VB when number under button BBUTTON1 is not reachable, busy or not pick up the calls - by ringing activate relay 1 and relay 2 - from this number are automatically received the calls
BBUTTON3	<ul style="list-style-type: none"> - this number is called by GSM-VB when number under button BBUTTON2 is not reachable, busy or not pick up the calls - by ringing activate relay 1 and relay 2 - from this number are automatically received the calls
BBUTTON4	<ul style="list-style-type: none"> - this number is called by GSM-VB when number under button BBUTTON3 is not reachable, busy or not pick up the calls - by ringing activate relay 1 and relay 2 - from this number are automatically received the calls
BBUTTON5	<ul style="list-style-type: none"> -this number is called by GSM-VB when number under button BBUTTON4 is not reachable, busy or not pick up the calls - by ringing activate relay 1 and relay 2 - from this number are automatically received the calls
BBUTTON6	<ul style="list-style-type: none"> - this number is called by GSM-VB when number under button BBUTTON5 is not reachable, busy or not pick up the calls - by ringing activate relay 1 and relay 2 - from this number are automatically received the calls
BBUTTON7	<ul style="list-style-type: none"> - this number is called by GSM-VB when number under button BBUTTON6 is not reachable, busy or not pick up the calls - by ringing activate relay 1 and relay 2 - from this number are automatically received the calls

<p>ADMIN2 to ADMIN7</p>	<ul style="list-style-type: none"> - by ringing activate relay 1 and relay 2 - By SMS activate relay 1 and relay 2 - By SMS read status and numbers in phone book - By SMS edit numbers and names on SIM card - By SMS control other features (AT commands) - By SMS setup parameters - From those numbers are automatically pick up calls
<p>ADMIN1</p>	<p>The same as ADMIN2 to ADMIN7 and moreover:</p> <ul style="list-style-type: none"> - to this number are sent reports by SMS with list of opening by ringing - to this number is sent SMS with info about low ACU battery level (option)
<p>BXX-Y</p>	<p>Phone number of buttons BXX (where XX is button number 01 to 85), dialed in order Y (where Y=1 to 7). In case Y>1, this number is called when previous number from line BXX is busy, not reachable or doesn't pick up the call</p> <ul style="list-style-type: none"> - by ringing activate relay 1 and relay 2 - from number are automatically received the calls
<p>MXXXX-Y</p>	<p>Phone number of memories XXXX (various 10 digits number) dialed from keypad in order Y (where Y=1 to 7). In case Y>1, this number is dialed when previous number from line MXX is busy, not reachable or doesn't pick up call</p> <ul style="list-style-type: none"> - by ringing activate relay 1 and relay 2 - from number are automatically received the calls
<p>CXXXXC</p>	<p>Code parameters XXXX (XXXX is various 10 digits number) dialed from keypad</p> <p>Mode 0: simple relay closing after code dial A#0 A – relay from which is code dialed [1,2]</p> <p>Mode 1: relay closed for setup days in week only A#1#CDEFGHI#JJ#K A — relay from which is code dialed [1,2]</p> <p>C – Monday: 1 permitted, 0 prohibited</p> <p>D - Tuesday: 1 permitted, 0 prohibited</p>

	<p>E - Wednesday: 1 permitted, 0 prohibited F - Thursday: 1 permitted, 0 prohibited G - Friday: 1 permitted, 0 prohibited H - Saturday: 1 permitted, 0 prohibited I - Sunday: 1 permitted, 0 prohibited JJ – number of permitted access 00-99, ** - then number not limited K – when code is used send SMS with date, time and code: 1 permitted, 0 prohibited</p> <p>Mode 2: relay closed in setup range of dates only A#2#CCDD#EEFF#G A – relay from which is code dialed [1,2] CC – from month [01 – 12, ** - various] DD – from day [01 – 31, ** - various] EE – until month [01 – 12, ** - various] FF – until day [01 – 31, ** - various] G – when code is used send SMS with date, time and code: 1 permitted, 0 prohibited</p> <p>Mode 3: relay closed from setup date A#3#CCDD#EE#F A – relay from which is code dialed [1,2] CC – from month [01 – 12, ** - various] DD – from day [01 – 31, ** - various] EE – number of permitted access 00-99, ** - then number not limited F – when code is used send SMS with date, time and code: 1 permitted, 0 prohibited</p> <p>Mode 4: relay closed in range of setup hours only A#4#CC#DD#EE#G A – relay from which is code dialed [1,2] CC – from hour [01 – 24, ** - various] DD – until hour [01 – 24, ** - various] EE – – number of permitted access 00-99, ** then number not limited F – when code is used send SMS with date, time and code: 1 permitted, 0 prohibited</p>
<p>Various name</p>	<p>- by ringing activate relay 1 and relay 2 - from number are automatically received the calls When name will be saved in format CODECXXXXC, when CXXXXC is code saved on SIM (via in table above), will be the same rules of code for this number for activating by ringing like is written in code</p>

ALARMON	- it is send to this number SMS „ALARM ON“ when input is closed against ground
ALARMOFF	- it is send to this number SMS „ALARM OFF“ when input is opened
VER	- version fw in GSM-VB - informing only- not change!
PARGDI	<p>- GSM-VB parameters</p> <p>A#B#C#D#E#F#G#H (default 4#4#0#0#1#5#0#2)</p> <p>A – microphone sensitivity [1-7] B – speaker loudness [1-7] C – incoming calls: 0 – no calls pick up (closing by ringing) 1 – pick up calls from SIM saved numbers only 2 – pick up all calls D – record who opened by ringing: 0 – off 1 – on E – time setup from GSM network: 0 – off 1 – on F – signaling: 7 – parameter is ignored (backward compatibility) G – input mode: 0 – off 1 – input grounded beeping to call (signaling of opened doors) 2 – SMS during connection/input disconnection H – waiting for dial next number in order</p> <p>Value is in number ten seconds (2 = 20 sec.)</p>
PARRL1	<p>- parameters for relay 1</p> <p>A#B#CC#D (default 5#1#03#1)</p> <p>A – DTMF code for close relay during call [0-9] B – relay mode: 0 – SMS mode, control by SMS 1 – switch mode, close by ringing from numbers on SIM card or by DTMF code during call 2 – camera mode (close by pick up, open by hang up) 3 – lighting mode (close by pick up, stayed closed for „closing time“ after hang up) 4 – button mode, close for „closing time“ after button press 5 – extra switch mode, close by ringing from any number or by DTMF code during call CC – closing time [00-99] D – closing of relay by ringing: 0 – off 1 – on</p>

PARRL2	<p>- parameters for relay 2</p> <p>A#B#CC#D (default 5#1#03#1)</p> <p>A – DTMF code for close relay during call [0-9]</p> <p>B – relay mode: 0 – SMS mode, control by SMS</p> <p style="padding-left: 40px;">1 – switch mode, close by ringing from numbers on SIM card or by DTMF code during call</p> <p style="padding-left: 40px;">2 – camera mode (close by pick up, open by hang up)</p> <p style="padding-left: 40px;">3 – lighting mode (close by pick up, stayed closed for „closing time“ after hang up)</p> <p style="padding-left: 40px;">4 – button mode, close for „closing time“ after button press</p> <p style="padding-left: 40px;">5 – extra switch mode, close by ringing from any number or by DTMF code during call</p> <p>CC – closing time [00-99]</p> <p>D – closing of relay by ringing: 0 – off 1 – on</p>
PARKEY	<p>Keypad parameters</p> <p>A#B (default 2#0)</p> <p>A – waiting time for press of next button [1-9] sec.</p> <p>B – permission/prohibition of phone number direct dialling:</p> <p style="padding-left: 40px;">0 – dial OFF</p> <p style="padding-left: 40px;">1 – dial ON</p>

The names with numbers might be saved into phone book on the SIM card via any mobile phone (process according the manual of an appropriate mobile phone). **The names ABUTTONx, BBUTTONx, ADMINx, ALARMON, ALARMOFF, PARGDI, PARRL1, PARRL2, button names (B...), memory names (M...), code names (C....C) must be written in CAPITAL (BIG) LETTERS. Between the letters there is not any space!**

Always save phone numbers of participants in international format (+.....)

Answer of GSM-VB to SMS „READ STAT“

READ STATUS:
VER: 105#5#3
BATTERY:4030mV
TIME:24/12/14,12:01:55
OPER: T-Mobile CZ
INP:1
RL1:OFF
RL1:OFF

Answer of GSM-VB to SMS „READ PAR“

READ PAR:
VOLIN:4
VOLOUT:4
INCALL:0
WRCALL:1
TMGSM:1
TONE:7
INPMOD:2
WAIT:20
RL1COD:5
RL1MOD:4
RL1TMON:03
RL1RING:1
RL2COD:6
RL2MOD:1
RL2TMON:05
RL2RING:1
WAITBUF:2
DDIAL:0

SMS example to GSM-VB parameters setup











WRITE PAR:
VOLIN:1
INPMOD:1
RL1COD:2

Tones GSM-VB

Except ordinary tones and signaling of GSM communication (ringing tone, busy tone, different operator messages), has GSM-VB own signaling.

	<p>High tone- notification GSM-VB identified not registration to GSM network (antenna disconnected) wrong PIN, dialling number to GSM network etc..)</p>
	<p>Middle high tone – control action GSM-VB read SIM, registrate to GSM network, measure voltage, reply to SMS etc...</p>
	<p>Low tone – error GSM-VB identify error (for example low voltage, no reaction of GSM for command,. It might reacts by unit restart</p>
	<p>High tone follows by middle tones repeated after cca 5 sec start and initialization of GSM-VB (registration to GSM network, SIM reading etc..)</p>
	<p>High tone repeated GSM-VB identified disconnection from GSM network (antenna disconnected, wrong PIN....)</p>
	<p>Middle high tone repeated during holding button time, then high tone Detection of button press, dialling of programmed number</p>

LED signaling

 <p>Yellow LED on PCB</p>		Do not light GSM-VB is switch OFF
		Flashing space and light the same length GSM-VB is logged to GSM network
		Short flashing in 9 sec. period GSM-VB is in programming mode
		Permanent light GSM-VB started GSM module
 <p>RED LED</p>		Do not light Stand by or GSM-VB is switched OFF
		Permanent light Incoming call ringing
 <p>Blue LED</p>		Do not light Stand by or GSM-VB is switched OFF
		Permanent light call established - call is running
 <p>Green LED</p>		Do not light Stand by or GSM-VB is switched OFF
		Permanent light during relay activation activating relay by code, ringing, SMS or after switch ON/restart of GSM-VB

Technical parameters:

Dimension	according used modules
Operating position	various
Operating condition	temperature: -20 to + 50°C humidity: 10% ÷ 80% when 30° C
power voltage	12 (9-24) V AC/DC, min. 500mA (optional backup battery Li-18650 min 2000mAh for approx. 35h of operation)
buttons	1 to 87 according used modules (for each button max. 7 numbers dialed progressively – max. length of each 24 digits) – capacity of saved numbers is limited by capacity of SIM card
keypad	max. length code name (password) or memory – 10 digits. Max length of phone numbers is 24 digits – capacity of saved numbers is limited by capacity of the SIM card
Relay 2x	switchable contact
Max. voltage	48V when I<1A
Max. current	2A when U<30V
Closing time by code	1 to 99 sec
Closing time by SMS	1 to 99 min
input:	0/5V
GSM 2G bands	3,8 (for EU)
GSM 4G bands	1,3,7,8,20,28A (for EU)
SIM card	3V, 1.8V



Alphatech spol. s r.o.

Jeremenkova 88

140 00 Praha 4

tel. +420 244 461 016

e-mail: info@alphatech.cz

Internet: <https://www.alphatech.cz>

our GPS coordinates (WGS 84)

N 50°02'35.5" E 14°25'42.0"

20.2.2025