

4G GSM relay controlled via SMS

GRL 4G



Installation and programming manual v3.2
from fw 204

The device is designed to remotely control 2 separate relays and send notification SMS or call stored voice messages when changing the status of 4 inputs (input on/off).

Basic technical parameters:

Power supply	9 to 24 Vdc, 500 mA
GSM networks	2G bands B3, B8 4G bands B1, B3, B7, B8, B20, B28A
Outputs	2x switching relay 1 A / 30VDC (60Vmax) (galvanically isolated)
Inputs:	4x 0/5V inputs, short-circuit activation
Dimension:	131 x 111 x 38.5 mm

Basic features:

- Replaceable backup battery
- Simple installation and setup (in the basic settings, you only need to store one phone number on the SIM card)
- After changing the input status, sending SMS to up to 7 numbers (PORTOPN1-7 and PORTCLS1-7) stored on the SIM card and simultaneously calling up to 7 phone numbers (PORTCALL1-7) also stored on the SIM card.
- Separate SMS text message for each state of each input (i.e. 8 different SMS text messages)
- Separate voice messages for each state of each input (i.e. 8 different voice messages)
- It is possible to set the relay states after switching on (relay open, closed, remember the last state before switching off)
- Possibility to remotely determine the current status of both relays, all inputs, temperature and power supply of the device via SMS text message.
- After calling the device, you can listen to a voice message with the current status of both relays and all inputs.

- Ringing can be used to control relay switching similarly as with the Alphatech GSM Door Intercom or the Alphatech GSM Key devices.
- The device can only be controlled and programmed from the numbers stored on the SIM card which is inside the device.
- You can work without or with the PIN code – automatic generation of random PIN code for the inserted SIM card.
- SMS control of up to 7 slave GRL4G devices from the master GRL4G device, or mutual control in a cascade.

Commissioning:

- If you wish to program the parameters directly to the SIM card by saving the numbers from any mobile phone, insert that SIM card into this mobile phone and program the SIM card.
- Turn off the PIN on the SIM card or set the PIN code to 0000 (see chapter SIM PIN). Insert the programmed (see previous point) or unprogrammed SIM card into the hole inside the device (see the figure below) and press it to secure the SIM card.

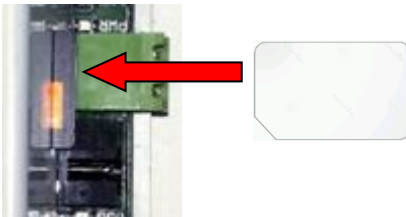

- If you have a backup battery installed, leave its switch in the down position (off).
- Connect the antenna.
- Connect the power.
- The blue power (PWR) LED lights up, flashes or the BAT LED lights up (see below).
- Within about 4 seconds, the yellow GSM LED lights up.
- During the next 30 sec. the GSM network will be logged in (yellow LED flashes, see the table later in the manual) and relays will be switched on (see RLxSTAT settings in the table later in the manual)
- The device is ready for operation.

SIM PIN

If you wish to operate the device with a SIM card without a PIN code, turn off the SIM PIN code (in any type of a mobile phone) before inserting the SIM card into the device.

If you wish to operate the device with a SIM card with a PIN code, set the PIN code to 0000 on the SIM card using any type of a mobile phone before inserting the SIM card into the device. The GRL4G device, after inserting a SIM card with such a PIN code changes itself the PIN code to another PIN code, it's derived from the GSM module.

- Each GRL4G has its own unique PIN code (within a 4-digit number, of course)
- If you wish to use this SIM card in another device, you need to know the PIN2 code from this SIM card. As you do not know the real PIN code, you will need the PIN2 code to set a new PIN code (for example again to 0000, for use in another GRL4G) – working with PIN/PIN2 code does not affect the saved data and settings. These remain on the SIM card.
- **ATTENTION! When inserting a SIM card with a PIN code other than 0000, the device will not work!** The only exception is when you insert the SIM card that has a PIN code set corresponding to the unique number of the GSM module. So, if you remove the SIM card after turning off the GRL4G device and insert it into the same GRL4G device again, the GRL4G device will continue to work without changing the PIN code.

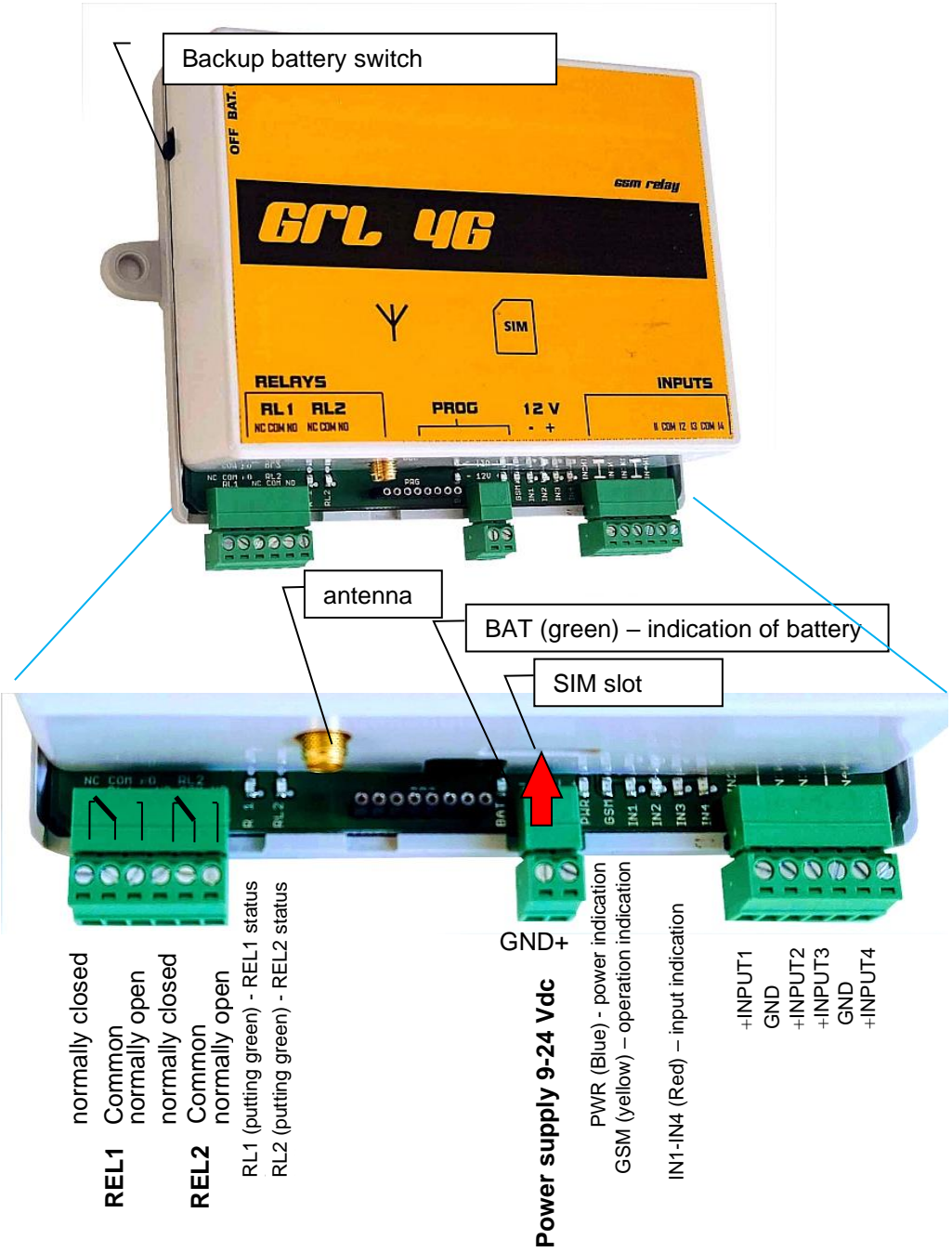

Backup battery switch

RELAYS

RL1 RL2
NC COM NO NC COM NO

PROG 12 V +

INPUTS

IN COM IN2 IN3 IN4

antenna

BAT (green) – indication of battery

SIM slot

normally closed
REL1 Common normally open
normally closed
REL2 Common normally open
RL1 (putting green) - REL1 status
RL2 (putting green) - REL2 status

GND+
Power supply 9-24 Vdc

PWR (Blue) - power indication
GSM (yellow) – operation indication

IN1-IN4 (Red) – input indication

+INPUT1
GND
+INPUT2
+INPUT3
GND
+INPUT4

Example of wiring:

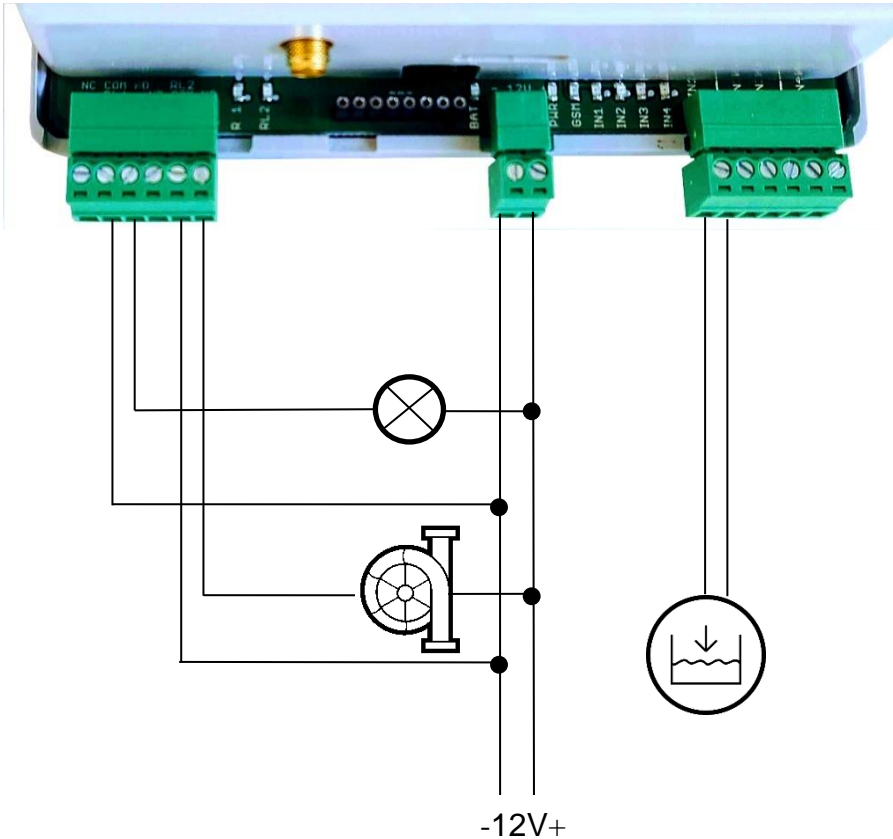











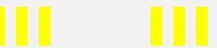

Sending SMS SET REL1 ON turns on the light

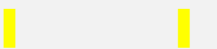
When the level rises, the sensor switches on the IN1 input and the device sends an SMS "P1 closed" (or another agreed SMS – e.g. "The level is above normal").

By sending SMS SET REL2 ON, the pump is switched on. After the level drops, the sensor opens the IN1 input and the device sends an SMS "P1 OPEN" (or, for example, "Level in normal"). By sending SMS SET REL2 OFF the pump switches off again.

LED signaling on the GRL4G device

Blue LED (PWR)		Continuous light Power on of GRL4G Continuous light – LED only glows/shines GRL4G powered by built-in backup battery
		Off GRL4G power off
Yellow LED (GSM)		Continuous light activation of the GSM module after switching on
		Blinking alternates for 1 sec. GRL4G initialization (network login, parameter reading, etc.) Preparation of acoustic path test
		1 to 5 short flashes GRL4G in standby mode, login to 2G network , the number of flashes corresponds to the strength of the GSM signal
		1 to 5 short double flashes GRL4G in standby mode, login to 4G network , the number of flashes corresponds to the strength of the GSM signal
		Flickering long light, short gap Calling in progress (connection)
		Flickering shorter light, short gap sending SMS messages
		Short blink every 9 sec. GRL4G is in programming mode ("OFF" mode)
		Fast short flashing running program in GRL4G terminated
Green LED (REL1, REL2)		Continuous light relay closed
		Off relay open
Red LEDs (IN1, IN2, IN3, IN4)		Continuous light port closed to ground (on port voltage < 1V)
		Off port open (on port voltage >2V and <10V)
Green LED (BAT)		Blinking alternates for 1 sec Backup battery not inserted
		Continuous light The backup battery is inserted and ready

Programming the GRL4G parameters via SMS text message

For security reasons, GRL **parameters can** only be set from numbers stored on the SIM card under the names ADMIN1 to ADMIN9.

SMS messages are always WRITTEN IN LARGE LETTERS

Individual SMS elements are always separated by a space (words). The first word is always a command. The next word(s) is one or more parameters.

Ex: INIT ADMIN1 +420123456789

All commands are in the appropriate table at the end of the manual.

1. During the first setup, when the SIM card does not contain any of the ADMINx names, it is necessary to enter such a number on the SIM card using an SMS with the INIT command. The SMS can be sent from any number. If the SIM card already contains at least one number with the name ADMINx, the command will not be executed.
2. If you need to control the relay, or set GRL from other ADMIN numbers: From the mobile phone with the ADMINx number, send an SMS with the numbers of other ADMINs **to GRL4G in** the form: WRITE ADMIN2 +420xxxxxxxx (WRITE ADMIN3... etc.)
3. From the mobile phone with the ADMINx number, send SMS text messages gradually to the GRL4G device. Send SMS text messages with the numbers to which SMS should be sent when the status changes on the inputs in the form: **WRITE** PORTOPN1 +420xxxxxxxx (WRITE PORTOPN2... etc.)
4. If the default parameters are not suitable, set the GRL **parameters** (see the table later in the manual). You can set the parameters individually, for each parameter by a separate SMS. If you need to set more parameters at the

same time, we recommend using SMS for a bulk setup. Using the "READ PAR" SMS, you can first load and read the current values of all parameters into your mobile phone. Use the SMS editor to change the word READ to WRITE in the received SMS and edit the parameter values according to the requirements (rows with parameters that you do not change can be kept or deleted). Send the edited SMS message back to the GRL4G device as a reply. The parameters will be set.

SMS command table

Command (SMS)		Function	Def.
SMS can be sent only from ADMINx numbers	READ ARTICLE	GRL4G status reading (version, temperature, relay states, input states, etc.)	
	READ PAR	Read all adjustable parameters	
	READ DEVICE	Read the saved device name	
	READ CALLOPN	Reading of listed inputs, when disconnected, the preset PORTCALL numbers 1-7 will be called	1234
	READ CALLCLS	Reading of listed inputs, when switched on, the preset numbers PORTCALL1-7 will be called	1234
	READ NAME	Read the phone number for NAME	
	CLR NAME	Delete a phone number for a NAME	
	INIT ADMIN1 +420cc... c	Initialization – first GRL4G setting – parameters can be programmed from ADMIN1 +420cc... c	
	SET REL1 ON [xx]	Switching on the relay 1 permanently or for [xx] minutes xx: 00-99	
	SET REL1 OFF	Switching off relay 1	
	SET REL2 ON [xx]	Switching on the relay 2 permanently or for [xx] minutes xx: 00-99	
	SET REL2 OFF	Switching off relay 2	
WRITE PAR INCALL:x	Incoming call processing: x: 0 - calls rejected (ringing) 1- received calls only from SIM 2 – all calls received	0	

WRITE PAR WRCALL:x	Sending SMS with the numbers from which it was opened 0 - disabled 1 - activated	0
WRITE PAR TMGSM:x	Set time according to GSM network x: 0 – off 1 - On	1
WRITE PAR WAIT:xx	Waiting for the next number in the list to be dialed xx – 10 to 90 seconds (in dozens)	2
WRITE PAR RL1MOD:x	Relay mode1 x=0 - SMS control x=1 - switch mode (by ringing from numbers to SIM) x=2 – camera mode (switches on by picking up, opens by hanging) x=3 – lighting mode (switches on by picking up, remains closed for "switching time" after hanging up x=4 – switches to "switching time" after activation of input IN1 x=5 – extra switch mode (by ringing from any number)	
WRITE PAR RL1TMON:yy	Relay actuation time1 after yy seconds yy=00-99	04
WRITE PAR RL2MOD:x	Relay mode2 x=0 - SMS control x=1 - switch mode (by ringing from numbers to SIM) x=2 – camera mode (switches on by picking up, opens by hanging) x=3 – lighting mode (switches on by picking up, remains closed for "switching time" after hanging up x=4 – switches to "switching time" after activation of input IN2 x=5 – extra switch mode (by ringing from any number)	
WRITE PAR RL2TMON:yy	Relay actuation time2 after ringing or when activated by code yy seconds yy=00-99	04
WRITE DEVICE xxxx-yyyyy	writing the name of the device, which then appears in the sent SMS with the input status xxxx-yyyyy is the device name without spaces and letters with hooks or commas	

WRITE CALLOPN xxxx	Writing of listed inputs, when disconnected will be called to preset numbers PORTCALL1-7 xxxx – series of numbers 1234 (see example) if xxxx=# will not call from any input	1234
WRITE CALLCLS xxxx	Writing of listed inputs, when switched on it will be called to preset numbers PORTCALL1-7 xxxx – series of numbers 1234 (see example) if xxxx=# will not call from any input	1234
WRITE PORTCALL1 yyyy	Writing the first yyyy phone number from the PORTCALLx series for calling when the status of any of the inputs changes	
WRITE SMS IN1OPN aaaaa	Text input aaaaa for notification SMS when input 1 is disconnected (max. 50 characters)	
WRITE SMS IN1CLS aaaaa	Text input aaaaa for notification SMS when input 1 is switched on (max. 50 characters)	
WRITE SMS IN2OPN aaaaa	Text input aaaaa for notification SMS when input 2 is disconnected (max. 50 characters)	
WRITE SMS IN2CLS aaaaa	Text input aaaaa for notification SMS when input 2 is switched on (max. 50 characters)	
WRITE SMS IN3OPN aaaaa	Text input aaaaa for notification SMS when input 3 is disconnected (max. 50 characters)	
WRITE SMS IN3CLS aaaaa	Text input aaaaa for notification SMS when input 3 is switched on (max. 50 characters)	
WRITE SMS IN4OPN aaaaa	Text input aaaaa for notification SMS when input 4 is disconnected (max. 50 characters)	
WRITE SMS IN4CLS aaaaa	Text input aaaaa for notification SMS when input 4 is switched on (max. 50 characters)	
WRITE NAME xxxxxxx	Writing the phone number xxxx for the NAME (switching the relay on by ringing)	

Command types:

READ – command for reading parameters, phone numbers from the SIM card or device memory

CLR - Command to delete phone numbers from the SIM card.

ATTENTION! If you use the SMS to delete numbers, at least 1 ADMINx number must remain in the system – otherwise it is no longer possible to program the device remotely (it is necessary to perform a new initialization).

INIT – Initialization. During the first setup, when the SIM does not contain any of the ADMINx names, it is necessary to enter such a number on the SIM card using an SMS with the INIT command. The SMS can be sent from any number. If the SIM card already contains at least one number with the name ADMINx, the command will not be executed.

SET – command for setting the relay status (on/off)

WRITE – command for writing parameters and phone numbers on the SIM card

The meaning of the names stored in the SIM card phonebook

name	Activity
PORTOPN1	- sends GRL4G SMS assigned to "INxOPN" when the input state is changed to disconnected (x = 1,2,3,4)
PORTOPN2	- sends GRL4G SMS assigned to "INxOPN" when the input state is changed to disconnected (x = 1,2,3,4)
PORTOPN3	- sends GRL4G SMS assigned to "INxOPN" when the input state is changed to disconnected (x = 1,2,3,4)
PORTOPN4	- sends GRL4G SMS assigned to "INxOPN" when the input state is changed to disconnected (x = 1,2,3,4)
PORTOPN5	- sends GRL4G SMS assigned to "INxOPN" when the input state is changed to disconnected (x = 1,2,3,4)
PORTOPN6	- sends GRL4G SMS assigned to "INxOPN" when the input state is changed to disconnected (x = 1,2,3,4)
PORTOPN7	- sends GRL4G SMS assigned to "INxOPN" when the input state is changed to disconnected (x = 1,2,3,4)
PORTCLS1	- sends GRL4G SMS assigned to "IN X CLS" when the input state is changed to disconnected (x = 1,2,3,4)
PORTCLS2	- sends GRL4G SMS assigned to "INxCLS" when the input state is changed to disconnected (x = 1,2,3,4)
PORTCLS3	- sends GRL4G SMS assigned to "INxCLS" when the input state is changed to disconnected (x = 1,2,3,4)
PORTCLS4	- sends GRL4G SMS assigned to "INxCLS" when the input state is changed to disconnected (x = 1,2,3,4)
PORTCLS5	- sends GRL4G SMS assigned to "INxCLS" when the input state is changed to disconnected (x = 1,2,3,4)
PORTCLS6	- sends GRL4G SMS assigned to "INxCLS" when the input state is changed to disconnected (x = 1,2,3,4)
PORTCLS7	- sends GRL4G SMS assigned to "INxCLS" when the input state is changed to disconnected (x = 1,2,3,4)
PORTCALL1	GRL4G calls the number when the status of any of the inputs changes (if the call is enabled in CALLOPN or CALLCLS) - switch relay 1 and relay 2 by ringing - calls are automatically received from the number
PORTCALL2	GRL4G calls the number if the number under PORTCALL1 is unavailable, occupied, does not answer the call for a long time - switch relay 1 and relay 2 by ringing - calls are automatically received from the number

PORTCALL3	GRL4G calls the number if the number under PORTCALL2 is unavailable, occupied, does not answer the call for a long time - switch relay 1 and relay 2 by ringing - calls are automatically received from the number
PORTCALL4	GRL4G calls the number if the number under PORTCALL3 is unavailable, occupied, does not answer the call for a long time - switch relay 1 and relay 2 by ringing - calls are automatically received from the number
PORTCALL5	GRL4G calls the number if the number under PORTCALL4 is unavailable, occupied, does not answer the call for a long time - switch relay 1 and relay 2 by ringing - calls are automatically received from the number
PORTCALL6	GRL4G calls the number if the number under PORTCALL5 is unavailable, occupied, does not answer the call for a long time - switch relay 1 and relay 2 by ringing - calls are automatically received from the number
PORTCALL7	GRL4G calls the number if the number under PORTCALL6 is unavailable, occupied, does not answer the call for a long time - switch relay 1 and relay 2 by ringing - calls are automatically received from the number
ADMIN1 to ADMIN7	- SMS to switch relay 1 and relay 2 - SMS to read status and numbers in the phone book - use SMS to edit numbers and names on the SIM card - use SMS to set parameters, device name and content of alarm SMS
CALLOPN	listed inputs whose disconnection will call the preset PORTCALLnumbers 1-7
CALLCLS	listed inputs that will be switched on to preset PORTCALLnumbers 1-7
VER	- version of fw in GRL4G – information only – do not edit!
PARGRL	- GRL4G parameters – informational only – do not edit!
PARRL1	- parameters for relay 1 – information only – do not edit!
PARRL2	- parameters for relay 2 – information only – do not edit!
TINPMIN	- Do not adjust the reaction times of individual inputs - information only – do not edit!

Names with numbers can also be saved in the phone book on the SIM card using any type of a mobile phone (follow the instructions for your mobile phone). **All names listed in the table (PORTOPN x, PORTCLSx, ADMINx, PARGRL, PARRL1, PARRL2 ...). It must be written in capital letters. There must be no space between names and order numbers (e.g., PORTOPN1).**

Examples of SMS communication with GRL4G

Example of setting the device name to "demo"

WRITE DEVICE demo

GRL Response:

WRITE DEVICE: OK

GRL response to SMS "READ STAT" (DEVICE=demo)

READ STATUS:

demo:

VER: 204

BATTERY:4030mV

PWR: 12.3V

TIME: 22/12/1 0.14:59

OPER: Vodafone CZ

TEMP: 28C

IN1: OPEN

IN2: OPEN

IN3: OPEN

IN4: OPEN

RL1: ON

RL1: OFF

If you wish to program some GRL4Gs parameters via SMS, we recommend that you first send the command to read the parameters: "READ PAR"

GRL response to SMS "READ PAR"

READ PAR:

RL1STAT:2

RL2STAT:2

TIN1:0001

TIN2:0001

TIN3:0004

TIN4:0004

Then just edit the received SMS – "READ" to "WRITE", edit the necessary parameter values and send the modified SMS back as a reply. In the reply, the GRL4G will only indicate the groups of parameters that have been edited. **ATTENTION!**

The length of the entire message must not exceed 1 SMS message (140 characters of a standard ASCII SMS)

WRITE PAR:
RL1STAT:2
RL2STAT:2
TIN1:0001
TIN2:0001
TIN3:0 0 10
TIN4:0 0 20

GRL4G Response:

WRITE PAR:
TIN1:0001
TIN2:0001
TIN3:0 0 10
TIN4:0 0 20

Example of SMS for setting GRL4G parameters

WRITE PAR:
RL1STAT:0
TIN4:0005

Example of CMM for switching REL1

SET REL1 ON

GRL4G Response:

SET REL1: OK

Example of wrong SMS for switching REL1

SET RL1 ON

GRL4G Response:

SET RL1: ERROR

Example of setting up notification SMS for input IN1

WRITE SMS IN1CLS Water in a container!

GRL4G Response:

WRITE SMS: OK

ATTENTION! The set SMS message must be without national characters (hooks, commas)! The length of the

text of the programmed notification SMS message is max. 50 characters!

Example of sent SMS message when switching on IN1 (default SMS= "Water in container!", name DEVICE= "demo"):

demo: Water in a container!

Example of setting calls when inputs 1 and 2 are switched on only. No calls when any input is disconnected.

WRITE CALLCLS 12

GRL4G Reply:

WRITE CALLCLS: OK

WRITE CALLOPN #

GRL4G Reply:

WRITE CALLOPN: OK

Determine which inputs the GRL4G will reply to by calling when they are switched on

READ CALLCLS

GRL4G Reply:

READ CALLCLS: 12

GRL4G with backup battery

If you already have purchased a GRL4G with a backup battery, check that the battery switch is in the lower position (switched off) before putting it into operation.

Do not store the device with the battery inserted unless the battery switch is in the lower position! Self-discharge may destroy the battery, which is not covered by the manufacturer's warranty.

Inserting a backup battery:

- Use only manufacturer-approved batteries: Li-Ion 18650, 2000-2600mAh
- Pay attention to polarity. Never insert the battery upside down! The device may be destroyed.

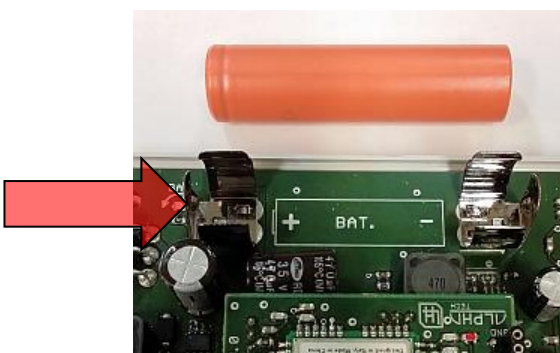

**BEWARE of polarity!
+ battery cap is
insulated from the
case**

**The switch must be
in the lower position!**



When the polarity of the battery is rotated, the red LED flashes or lights up.



If everything is correct, connect the power supply, and then move the switch to the upper position. – Connect the backup battery to the system.

Test the battery backup to function properly by disconnecting the main power supply.

The manufacturer is not liable for defects caused by non-compliance with the prescribed procedure.

Examples of GRL4G wiring:

Contactor connection 1SBE111111R1420 ABB (16 A; 12VAC; 12VDC; NO x2) for heating control – contactor connected to REL2

WRITE PAR RL2MOD:0

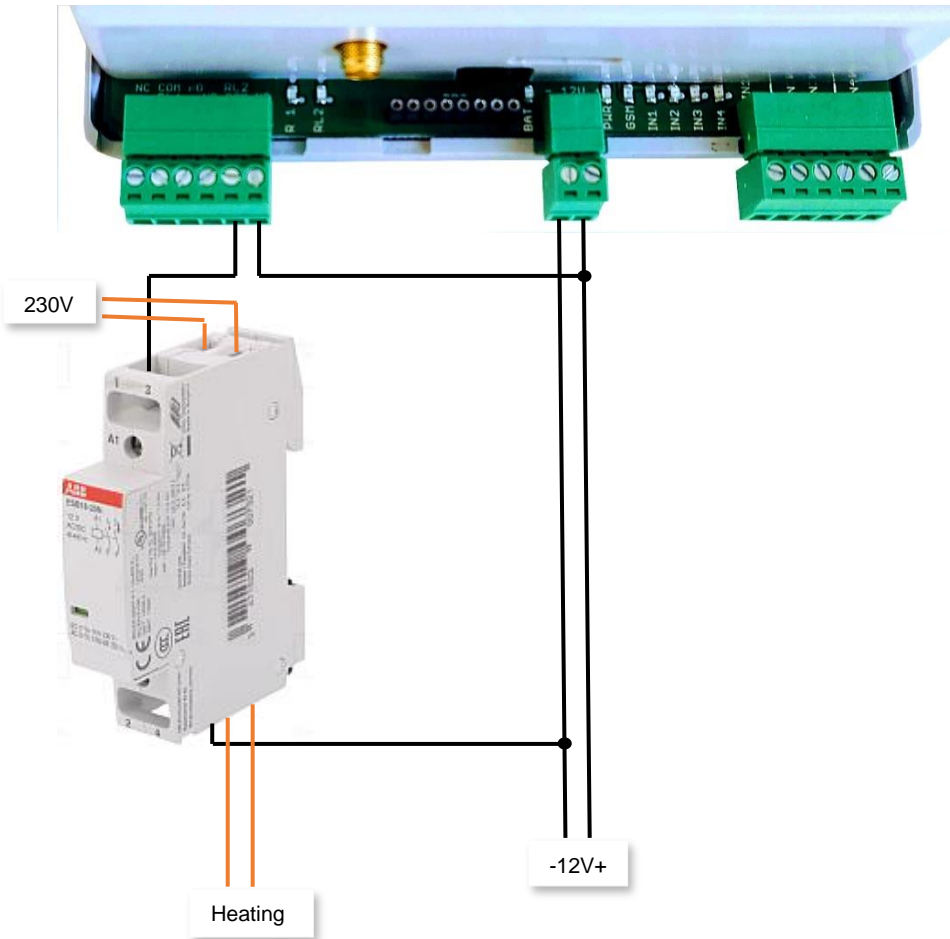

Connection of the door lock for opening by ringing from a mobile phone and with the exit button

WRITE PAR:
RL1MOD:1
RL2MOD:4

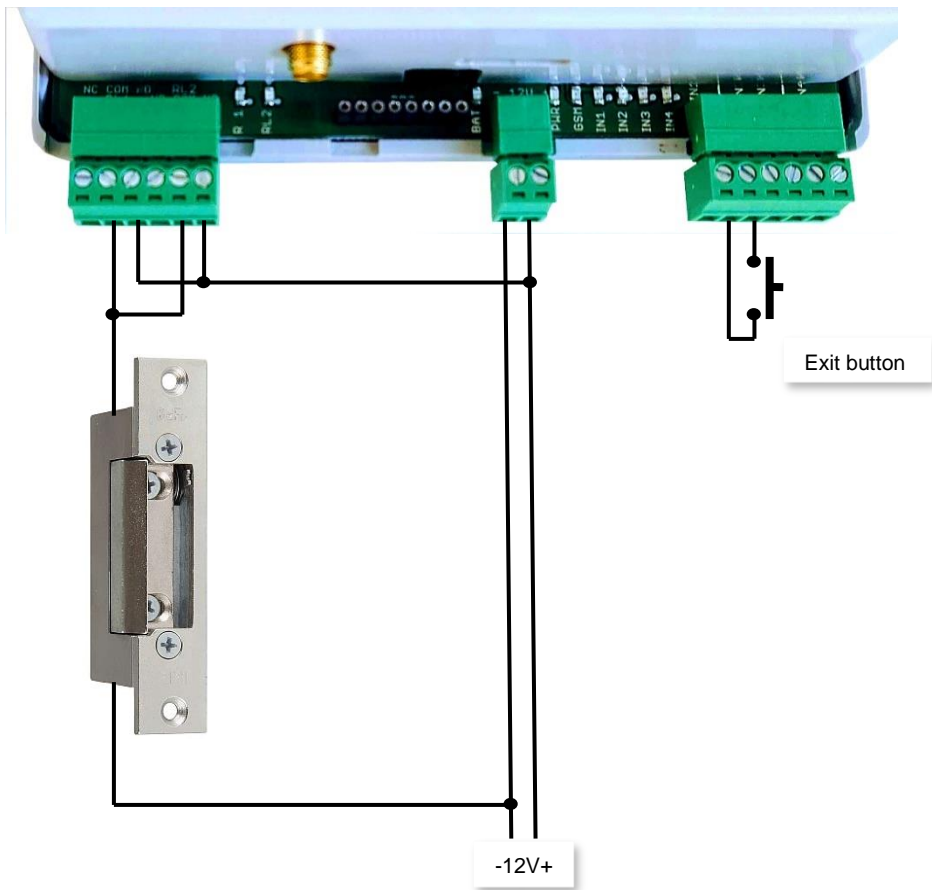

Connection of the motor drive of the gate – ringing (short activation) opens the gate partially (for pedestrians), sending an SMS message opens the gate fully (entrance)

WRITE PAR:
RL1MOD:1
RL1TMON:02
RL2MOD:0

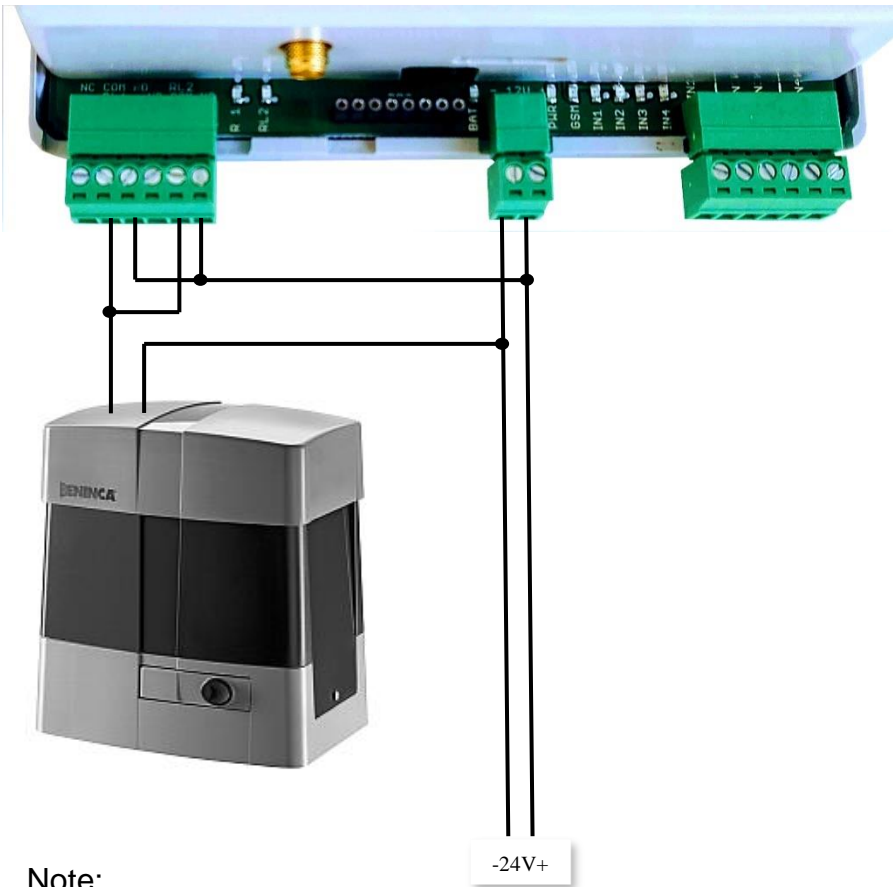

Note:
Ringing switches the control on for 2 sec – small opening
By sending the SMS *SET REL2 ON 0*, the control is switched on for 10 sec.

Demonstration example of the GRL4G Master-Slave wiring:
According to the level sensor in the water tank on the hill, the pump motor is switched on to the well in the valley
(disconnecting the "lower level" contact gives the command to start the pump, switching the contact "upper level" gives the command to turn off the pump)

GRL4G "Master" settings:

```
WRITE SMS IN1OPN SET REL1 ON  
WRITE SMS IN2CLS SET REL1 OFF  
WRITE PORTCLS1 xxxxxxxxxx  
WRITE PORTOPN1 xxxxxxxxxx
```

Where xxxxxxxxxx is the SIM card phone number in the "Slave" GRL4G

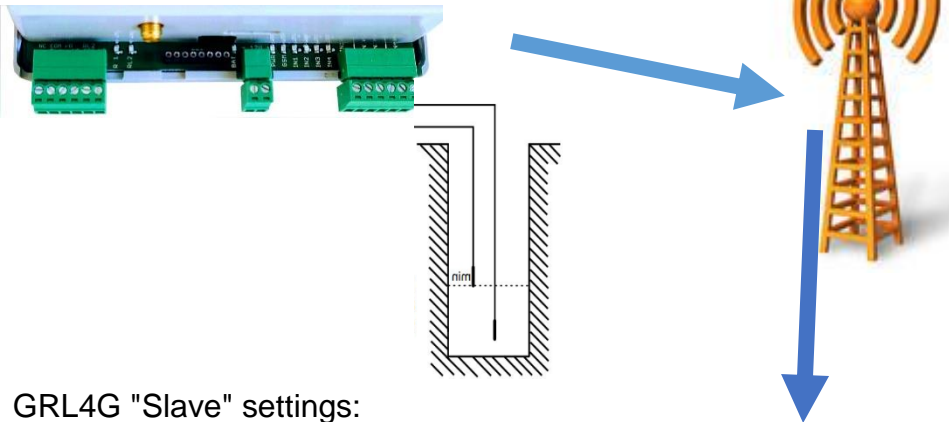

GRL4G "Slave" settings:

```
WRITE ADMIN7 yyyyyyy  
WRITE PAR RL1MOD:0
```

Where yyyyyyy is the SIM card phone number in the "Master" GRL4G

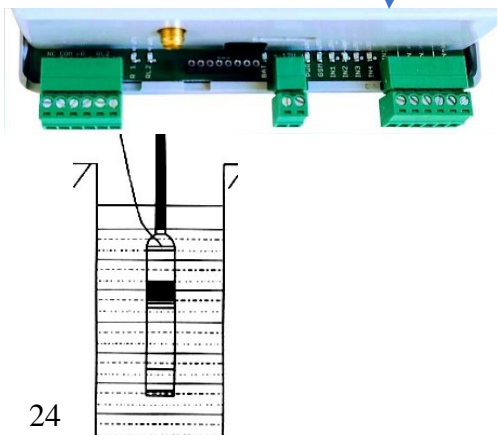



Alphatech spol. s r.o.
Jeremenkova 88
140 00 Praha 4
tel. 244 461 016

E-mail: info@alphatech.cz
Internet: <https://www.alphatech.cz>
our GPS coordinates (WGS 84)
N 50°02'35.5" E 14°25'42.0"

26.7.2023