

GSM LIFT COMMUNICATION SYSTEM

GSM Lift Watch *Voice* 4G

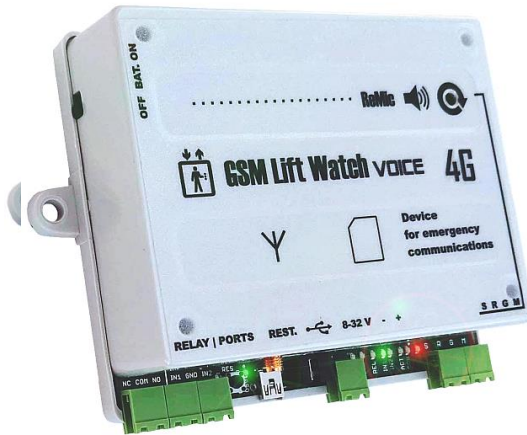

Installation and programming manual 2. 0

from FW 105

The device is designed for emergency voice connection of the lift cabin with the emergency service, firefighters, police, attendants, etc. The device meets the requirements of EN 81-28+AC:2019-04 and EN 81-70. In addition to the file format for voice messages, it is fully compatible with the previous GSM LiftWatch Voice. The motherboard remains the same. Therefore, all hardware connections are identical and compatible with the previous type. After moving the SIM to GSM LiftWatch Voice 4G, all programmed parameters and called numbers will also be preserved. In existing installations, it is therefore possible to replace piece for piece.

Note: The passages in the manual marked GLWV are general, valid for a wide range of devices. With the designation GLWV4G is a description of features valid only specifically for this type of device.

### **Basic technical parameters:**

Power supply	8 to 30 V DC, 50 to 500 mA (depending on operation) Built-in Li-Ion battery 2000 mAh – approx. 12 hours of standby operation
GSM networks	2G bands B3, B8 4G bands B1, B3, B7, B8, B20, B28A
Ext. signaling	LED or bulb 12 V (24 V) max.100mA
Inputs	2x – 1x call blocking, 1x universal
Outputs	1x changeover contact relay 24 V/100 mA
PC connection	2x MiniUSB (1x setup, 1x 4G modem)
Base unit	131 x 111 x 38.5 mm
ReMic	A/L1 module 110 x 78 x 38 mm (without mounts)
ReMicAS1 module	135 x 66 x 22 mm

## Basic features:

- No telephone line needed at the point of use
- Possibility of audio units for cabin, shaft and engine room (ReMic A1, ReMicAS1, ReMicL1, ReMicB + PREPOJ) – simultaneous connection of all units with the control room / connection of only the engine room with the audio units in the shaft and cabin.
- Replaceable backup battery
- Simple installation and setup (basic only saving of one phone number per SIM)
- After activation sequential calls to up to 7 numbers (MASTER1-7) stored on the SIM card. Numbers other than programmed numbers cannot be called.
- Automatic check call once every 1-9 days to one of the TEST numbers (TEST1-7) stored on the SIM card
- Adjustable emergency call interlock (block delay/block prolongation) - if the call button is held for more than 30 s, the call is made regardless of the lock (EN 81-28:2018)
- Indication of established, ongoing connection and other device states by switches for optical signaling and acoustically (voice) – possibility to record your own messages
- Relay mode for elevator blocking in case of GLWV failure/malfunction (GSM network login, correct battery voltage, unlocked emergency call button)
- Callback only from numbers stored on the SIM card, other calls blocked
- Automatic call termination after 5 minutes
- Standalone acoustic path test (speaker/microphone/ReMic connection check)
- "Emergency" status with storage of the time and date of call-up, cancellation locally (technician) or remotely (SMS) according to EN 81-28:2018

- During the "Emergency" state called blocking is canceled, incoming calls are possible from any number. Answering calls is not blocked.
- SMS with notification of low power status (adjustable value), SMS with notification of power return above the prescribed limit, SMS with notification of low voltage status of built-in backup battery
- Records of the number of service interventions on the lift with the date of the last intervention.
- Exact time and date from GSM network
- Forwarding of operator SMS to a preset number (TEST8)
- Work without / with PIN code – automatic generation of random PIN for SIM card
- Command SMS mode for remote control (SMS can be sent only from TESTx numbers):
  - Setting all parameters
  - Relay contact control
  - Finding out the status of the device (power and battery voltage, "Emergency" time, operator, temperature, lock and input status, relay state, acoustic test result...)
  - Cancellation of the "Emergency" state
  - change of MASTER and TEST numbers (numbers to which the number is called)
  - GSM network status detection
  - SMS with GSM module AT commands
- Sending customizable SMS when input status changes – separate SMS for both input states
- SMS when blocking the button for longer than 60 sec.
- 7 switching modes for relay contacts
- MiniUSB for 4G modem (Internet connection), simultaneous call and data transfer

## Setup/Programming

Basic – 3 ways:

- 1) If you use a SIM removed from the previous GSM LiftWatch Voice type, you just insert this SIM into the new device. All settings (except SMS) are transferred automatically to the new device
- 2) Insert the SIM into a regular mobile phone and save the required emergency phone number with the name MASTER1 or TEST1 on the SIM (for details, see chapter Programming).
- 3) Commissioning the device (see chapter Commissioning). Send an SMS "INIT TEST1 xxxxxxxx" (xxxxxxx is the number from which you will program the GLWV) to the SIM number entered in the GLWV. Wait for a response ("OK"). From the number TEST1 send an SMS "WRITE MASTER1 yyyyyy" (yyyyyy is the number to which GLWV will call when the button is pressed).

Detailed settings:

- 1) GLWVset setup program
- 2) By SMS

Detailed settings/programming of individual parameters will be discussed in the appropriate chapter.

## Emergency call from the elevator cabin

After activating the device with the button (adjustable time of pressing the activation button), the I1 port on the ReMic is switched on (to turn on the yellow indicator light – activation/establishing connection), the message "dialing, wait" is heard and the system gradually dials phone numbers stored under the names MASTER1 to MASTER7 on the inserted SIM card. The message "Dialing, wait" is always activated again before dialing the next number in the sequence. After establishing a connection with the counterpart station, no more numbers are dialed. Ports I1 and I2 (yellow and green lights) are closed/unclosed according to the ReMic type used (and standards – see table). The message "Elevator Emergency Communicator" is activated. (the location of the lift can be played). The system returns to standby by ending the call with the counterpart station. Disconnect port(s) (I1,) I2 to ReMic (see table) and the message "call is terminated" is activated.

	Indication according to the ReMic used	
status	Indications to date (ReMicA, ReMicB, ReMicL)	Indications according to EN 81-28:2018 (ReMicA(S) <sup>1</sup> , ReMicL1)
Initiating a connection	Activated I1 (yellow)	Activated I1 (yellow)
Connection established	Closed I2 (green)	I1 and I2 closed (yellow and green lit)
Connection terminated	Open I2	I2 is open, I1 remains closed until the end of the EMERGENCY state. *

\* Applies when the "EMERGENCY mode" function is enabled. Otherwise, the EMERGENCY(ALARM) state is automatically terminated when the call is ended and I1 is also opened.

Example 1 (indication according to EN 81-28:2018):

*Set*

*MASTER1 and MASTER2 numbers*

*Activation Time (WACT) 3 s*

*waiting for next number dial (WCAL) 20 s*

*Emergency alarm mode (ECALL) set (=1)*

After pressing the button for more than 3 s, port I1 is switched on, the EMERGENCY(ALARM) state is activated, the message "Please wait for connection" is heard, the number stored under MASTER1 is dialed. No one answers. After 20 s after dialing the number, the call is terminated. The message "Please wait for connection" is activated again and the number saved under MASTER2 is dialed. The called party will pick up. Port I1 remains closed, and port I2 is also closed. The message "Emergency communicator of the lift" is activated. A call is in progress. The called party ends the call. Port I2 is opened. The message "call is ended" is activated. Port I1 (yellow light) is still on because the EMERGENCY(ALARM) state still persists. The EMERGENCY(ALARM) state is canceled by SMS "RESET ECALL". Port I1 is opened.

Example 2 (indication according to EN 81-28:2018):

*Set*

*numbers MASTER1, MASTER2, MASTER5*

*Activation Time (WACT) 3 s*

*waiting for next number dial (WCAL) 20 s*

*Emergency alarm mode (ECALL) set (=1)*

After pressing the button for more than 3 s, port I1 is switched on, the EMERGENCY(ALARM) state is activated, the message "Please wait for connection" is heard, the number stored under MASTER1 is dialed. No one answers. After 20 s after dialing the number, the call is terminated. The message "Please wait for connection" is activated again and the number saved under MASTER2 is dialed. No one answers. After 20 s, the call is terminated the system detects that the next number in the series (MASTER3) is not saved, activates the message "The

connection failed. Please try again in a moment." Port I1 remains closed (EMERGENCY(ALARM) is activated). The MASTER5 number (numbers stored after the interrupted series) therefore serves only as a number from which it is possible to automatically answer the call.

## **Emergency call blocking**

Emergency call activation can be blocked by short-circuiting the IN2 blocking input. You can set both the switching time of the port necessary to activate the blockage and the time during which the block is still active even if the port is already disconnected. If the button is pressed during blocking (pressing the button for the time necessary to activate the emergency call), the message "The emergency call is still blocked" is activated. Please try again in a moment." However, if the button is pressed for more than 30 seconds, the blocking is canceled and the emergency call is activated (EN 81-28:2018)

### **Example1**

*Lock connected to door contact, open door – port short-circuited.*

*Settings:*

*Short circuit of the 3 s blocking port*

*Persistence of locking after disconnecting the contact 65 s (time of the longest lift ride)*

The elevator doors close, the elevator starts, the call is blocked. After pressing the button, the message "Emergency call is still blocked. Please try again in a moment."

### **Example2**

*Lock connected to door contact, open door – port short-circuited.*

*Settings:*

*Short circuit of the 3 s blocking port*

*Persistence of locking after disconnecting the contact 65 s (time of the longest lift ride)*



The elevator doors close, the elevator starts, the call is blocked. The elevator stops, the doors do not open. The operator tries to open the door manually, pressing various buttons. The set blocking period has passed yet. The operator presses the emergency communication button. - To be continued, see Examples of emergency calls.

### Example3

*Blocking connected to the output of the lift fault state, lift failure – port shorted.*

*Settings:*

*Short circuit port for blocking 1 s*

*Persistent locking after disconnecting contact 1 s*

An emergency call is possible only in the event of an indicated lift malfunction

**Attention:** If the emergency communication button is pressed for more than 30 seconds, the call is made even when it is blocked (EN 81-28:2018).

### Callback

You can also activate your device by calling its phone number. Only numbers listed on the SIM card will be connected. Other numbers are ignored. Thus, even without the assistance of the lift crew, it is possible to reestablish the connection and control the situation in the lift cabin. When a connection is established, the message "Emergency communicator of the lift." is played for possible identification. In the "Emergency" state, the communicator receives calls from any phone number.

## **Test (check) call**

If the SIM card stores numbers under the names TEST1 to TEST7, these numbers are automatically called once in the set number of days (default 3 days). The device behaves similarly as when pressing the button, only it is called to a different set of phone numbers (not MASTER, but TEST) and the blocking port is ignored. Furthermore, for differentiation, when the connection is activated and established, the message "Attention, this is a connection test" is played. After the connection is terminated, the message " call is ended" is played normally. Of course, the phone numbers can be identical in both sets if necessary.

At the same time, except for or instead of the check call, only the local acoustic path (GLWV – line – ReMic speaker – ReMic microphone – GLWV line) can be tested. During the test, the message "Sound check – one, two, three, four – end" is activated. GLWV measures the change in signal level picked up by the microphone between the idle state and the sound level during a message. Testing will not be reliably evaluated with high ambient noise – no or small change in signal level. The test is able to detect even an unconnected ReMic or a shorted microphone.

At the same time, an SMS TEST can also be sent with information:

Version fw

Backup battery voltage

Supply voltage

Set date and time in GLWV

Operator

Temperature in GLWV

Number of service interventions with date last (1)

Input status IN1

Locking status (input IN2)

Relay status

Date and time of last emergency call (2)

Acoustic test result (3)

- 1) If the "Service OK" mode has been set
- 2) If the "Emergency" mode is set, it shows the date and time of the last mode activation. When the mode is deactivated (remotely or locally), this state is signaled by "\_ \_"
- 3) If the acoustic test and sending SMS TEST are enabled, the acoustic test is performed first to indicate the current status in the SMS TEST.

If the connection fails, ports I1 and I2 alternately switch/open in a rhythm of one second. The alternating flashing lasts until another outgoing call (alarm or test) is made - EN 81-28:2018.

## Presence information (SMS)

GLWV sends status information via various SMS:

- **TEST/STATUS:** SMS see previous point. In addition to the test, it can also be called up using the "read status" SMS (more in the SMS chapter). If an acoustic path test is set, it will always be performed before sending this SMS.
- **Power Information:** The 'Power LOW' SMS is sent to TEST8 when the supply voltage is reduced below the set limit for more than a minute. The 'Power OK' SMS is sent to the TEST8 number if the supply voltage rises above the set limit for more than 1 minute (after warning of the drop).
- **Information when the built-in battery is discharged:** The "Low Voltage" SMS is sent to the TEST8 number when the battery voltage drops below the specified limit (3.3 V). After that, the device works correctly for about 1 hour. If the power is restored after this time, the device behaves as after switching on (no SMS 'Power OK' is sent).
- **Information about the change of the state of the IN1 input: SMS with information about the change of state from open to closed ('PORT OPEN') is sent to**

**the number** PORTOPEN, SMS with information about the change of state from closed to open ('PORT CLOSE') is sent to the number PORTCLOSE. If the "Emergency alarm" mode is set, the SMS 'Reset last Emergency Call' is sent to the PORTCLOSE number when the IN1 port is switched on (i.e. emergency state reset), if service is set, SMS 'SERVICE' is sent when the port is switched on

- **Button** locking: If a short circuit is detected on the emergency call activation button (e.g. blocked button) for more than 1 minute, an SMS 'Button blocked' is sent to the TEST8 number.
- **Information from the operator:** If the operator's number is stored on the SIM under a name that includes the word stem "oper", all SMS messages received from this number will be forwarded to the TEST8 number.

The content of all SMS (texts of all SMS) can be changed according to the requirements using the GLWVset setting software (see below).

## **Emergency alarm mode**

With this setting, the „emergency „ state (Alarm) is activated when an emergency call is activated (EN 81-28:2018). The date and time of this status is recorded for registration in SMS STATUS. Depending on the settings, the relay can be switched on during the "emergency" – status indication, activation/blocking of other activities in the lift. The "emergency" status can be cancelled according to the settings either by short circuit on the IN1 port (technician on site after solving the emergency call case) or remotely via the SMS 'RESET ECALL'. During this state, the blocking of pressing the button via IN2 is canceled and incoming calls are made only from allowed numbers (incoming call can be from any number).

## Relay

At present, it is possible to program the relay into one of 7 modes:

- Switching on/off is controlled via SMS (e.g. "SET REL1 ON")
- Switching on/off is controlled by the "emergency" state (see previous chapter)
- "Camera" mode, when the relay switches on after establishing a connection (pickup) and opens after the connection is finished
- "Running" mode for possible lift blocking: Switching on/off is controlled by the status of the device – its readiness (functionality) for an emergency call. The relay is switched on if the device is connected to the GSM network, there is sufficient voltage on the backup battery (internal voltage of the device) and the emergency call button is not blocked (permanently pressed). Connect the contact to the appropriate input of the lift control electronics. The lift control electronics shall ensure that after disconnection/connection of the contact (changeover relay), the lift reaches the nearest station, opens the doors and remains out of order.
- The "lighting" mode, when the relay switches on after establishing a connection (as in the "camera" mode), but after the connection is terminated, the relay is switched on even further for an adjustable time.
- "Button" mode, when the relay switches on after pressing the emergency call button and remains closed for an adjustable time.
- "Service OK" mode. In this mode, the relay is switched on for an adjustable time after a short circuit on the IN1 port. At the same time, the SMS 'SERVICE' is sent to the number stored under PORTCLOSE and the current date with the number of previous short circuits to N1 is stored

in the phone number under the name SERVICES (announcement "Service OK")  
Information about the relay status is in SMS TEST/STATUS.

## **SIM PIN**

If you want to operate the device with a SIM card without a PIN, turn off the SIM PIN (in any mobile phone) before inserting the SIM into the device

If you want to operate the device with a SIM card with a PIN, set the PIN to 0000 using any mobile phone before inserting the SIM into the device. GLWV after inserting a SIM card with such a PIN itself changes the PIN itself to another PIN – derived from the given GSM module.

- Each GLWV has its own unique PIN (within a 4-digit number, of course)
- If you want to use this SIM in another device, you need to know the PIN2 from this card – because you do not know the real PIN, you will need PIN2 to set a new PIN (for example again to 0000, for use in another GLWV) – working with PIN/PIN2 does not affect the saved data and settings. These remain on the SIM.
- **ATTENTION! When inserting a SIM with a PIN other than 0000, the device will not work!** The exception is the insertion of the SIM that has a PIN set corresponding to the unique number of the GSM module. So, if you remove the SIM after disabling the GLWV and insert it into the same SIM again, the device will continue to work without changing the PIN.

# Parts of GSM Lift Watch Voice 4G:

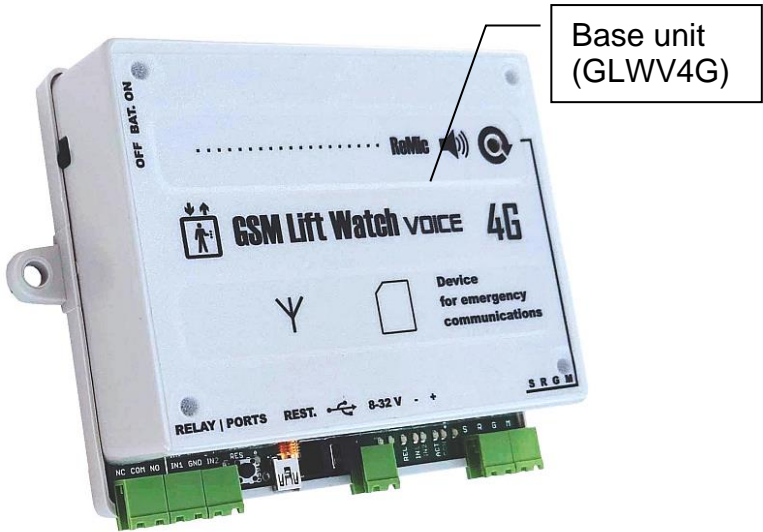

Base unit (GLWW4G)

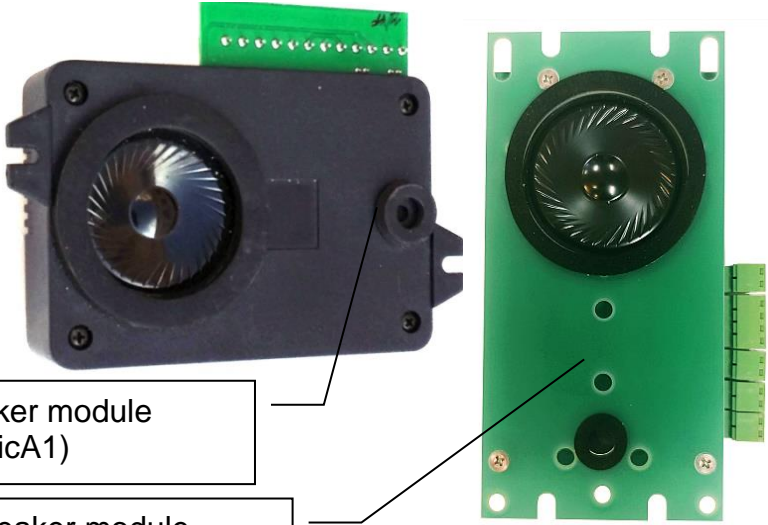

Speaker module (ReMicA1)

Speaker module (ReMicAS1)

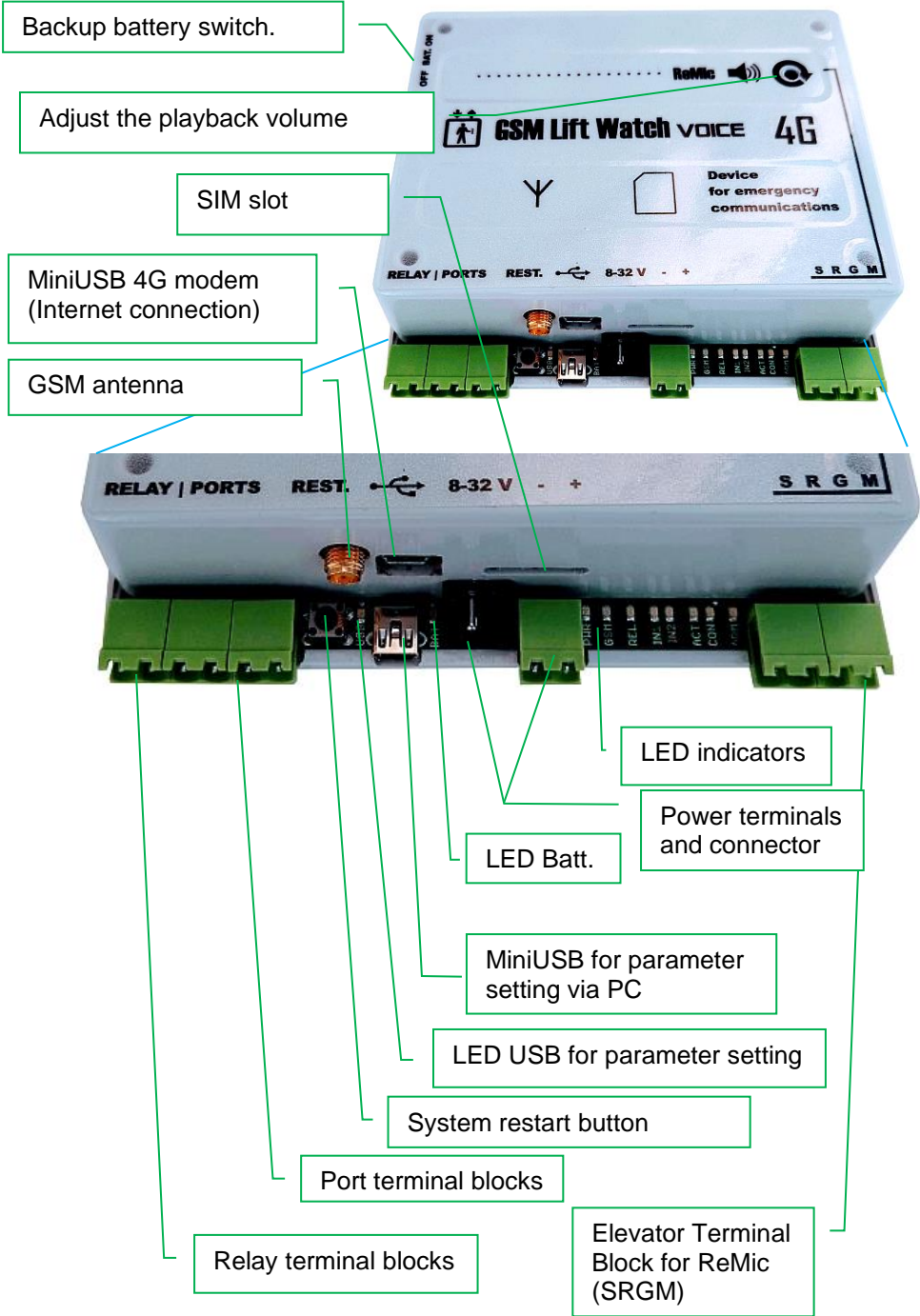



## Port terminal boards (IN1, IN2) and relays



IN2 lock input  
(by shorting to the ground)

Common clamp – ground

Input IN1

Relay Contact Terminal  
(Disconnected at rest – NO)

Common terminal of relay  
contacts

Relay Contact Terminal  
(Connected at rest – NC)

## LED indicators

PWR – power

GSM – signal strength, operation..

REL – relay closed

IN1 – IN1 active (short to ground)

IN2 – IN2 active (short to ground)

ACT – emergency call activated

CON – connection established  
(picked up)

ARM – press the emergency call  
button



## Elevator Terminal Block for ReMic (SRGM)

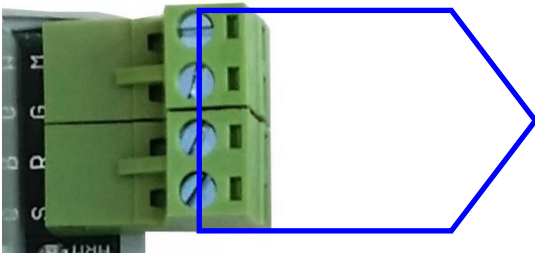

Terminals for connection with the ReMic module in the lift – the same marked terminals are connected  
 M – microphone  
 G – ground  
 R – speaker  
 S – signalling

## Terminal block for ReMicA1 (ReMic) speaker module

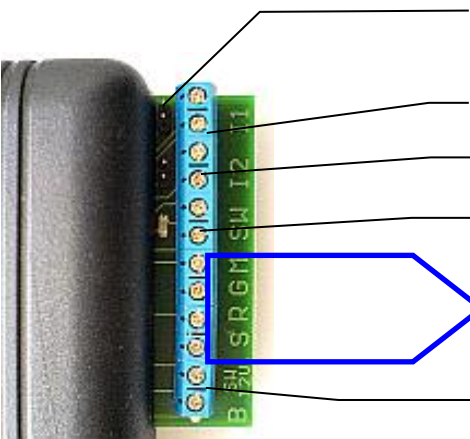

Jumpers, current limitation by switches (see examples of wiring), terminals, call activation by applying a voltage of 12V

Indicator switch terminals I1

Indicator switch terminals I2

Call activation button terminals

Terminals for connection with the basic unit – the terminals marked with the same designation are connected (see above)

Insulated call activation terminals by applying 12V voltage

## Terminal block of ReMicL1 speaker module

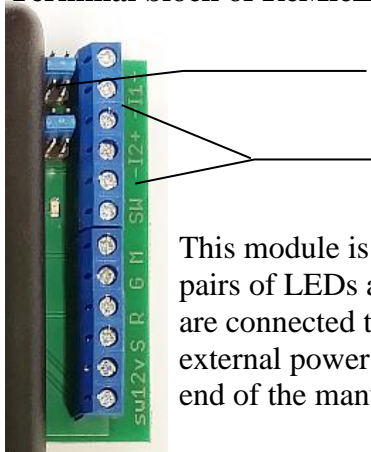

LED Jumpers of Choice

Terminals for connecting the LEDs themselves (I1, I2)

This module is intended only for LED indication – two pairs of LEDs are built directly into the module; others are connected to terminal I1 and I2. They do not need external power supply (see examples of wiring at the end of the manual)

## Terminal block of ReMicAS1 speaker module

The module is a variant of ReMicA1 designed for low panel installation (height 22 mm)

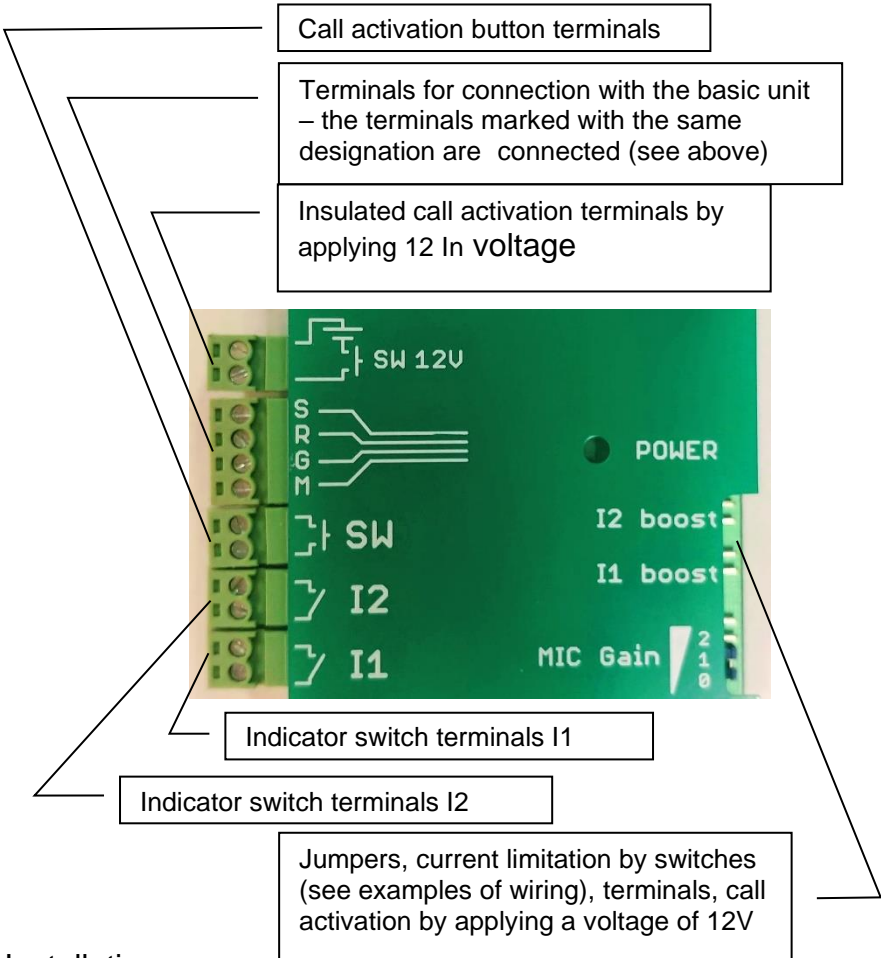

### Installation:

- Attach the speaker module (ReMicA(S)/L1) behind the grille on the panels in the elevator cabins. For good audibility, especially of calls from the cabin, we recommend placing it at head height. **There must be a hole in the grid in front of the microphone, otherwise the call from the booth will be poorly audible!**



The speaker and microphone are facing the panel

method of fastening on the back of the lift panel (e.g. pinned screws)

### ReMicA/L1

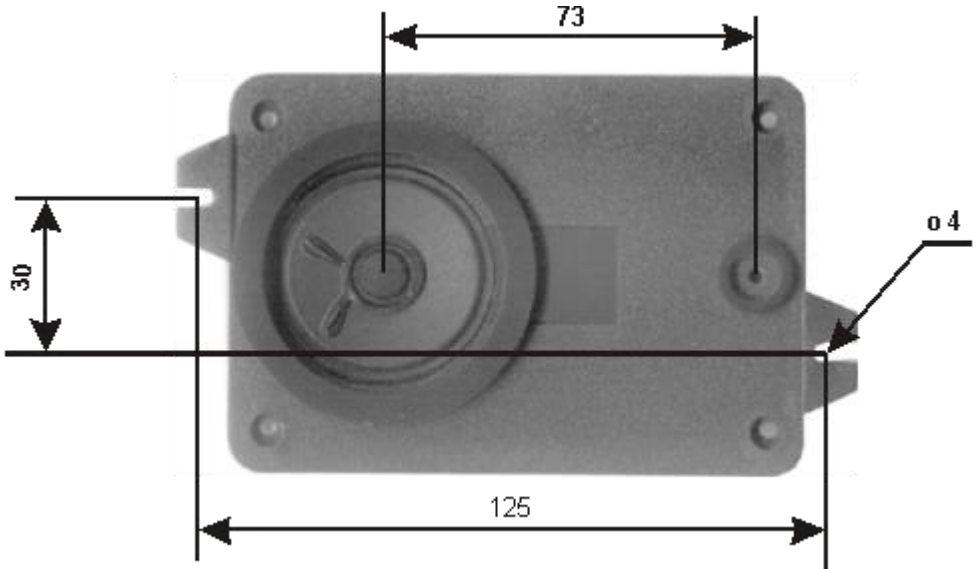

## ReMicAS1



- Mount the GSM module either in the lift cabin or in the engine room. It is necessary to take into account the strength of the GSM signal. Installation on the lift cabin is easier (there is no need for a cable from the engine room to the cabin, and thus the likelihood of interference is reduced), but it is necessary to provide a GSM signal along the entire length of the elevator shaft. Make sure you have enough space to handle the SIM card.

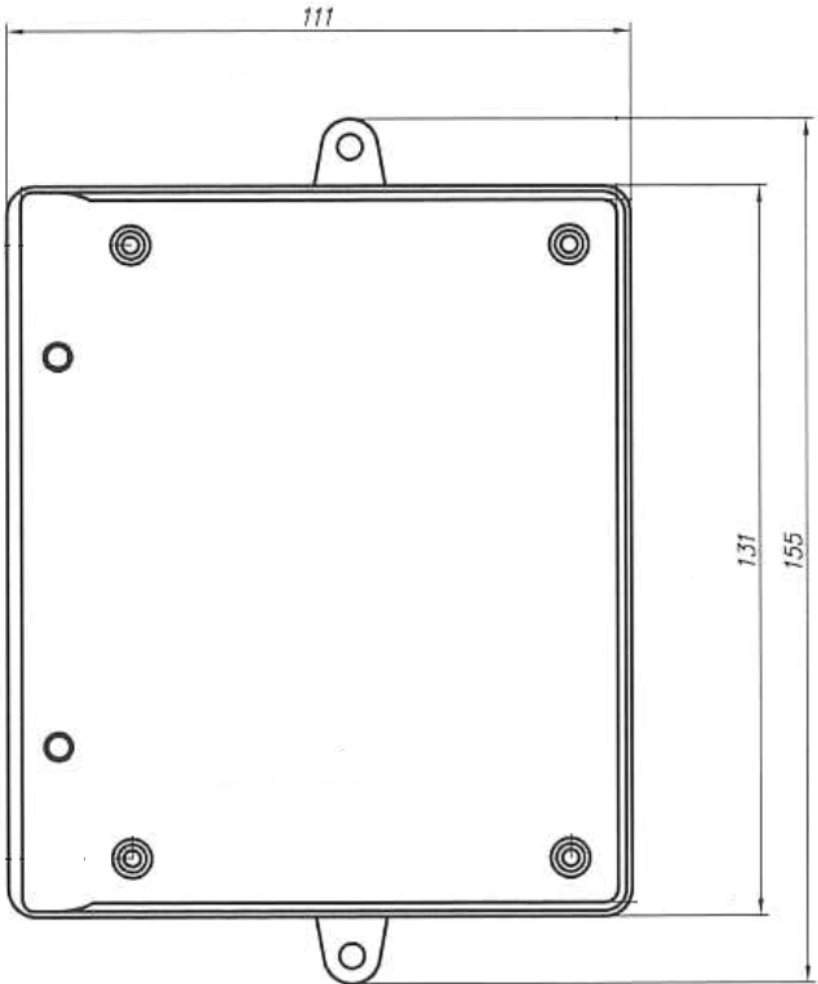

- Screw in the antenna cable connector. The antenna must not be placed inside metal-clad spaces (metal cabinets, metal shafts, etc.) that cause attenuation of radio waves. When connecting a "magnetic" antenna, make sure to place it on a larger iron object. This object creates a so-called counterweight, the size of which depends primarily on the size of the radiated power. Antenna radiation may interfere with the device's speech path (interference known eg. from

car stereos when talking on the phone in the car). It is therefore advisable to place the antenna as far as possible from the device or, for example, behind a wall. Interference can also change by changing the location of the antenna (sometimes centimeters can be affected).

- According to the diagram, connect the speaker modules (ReMic) and the base unit. Connect an indication and button to the speaker module. Do not connect ports to the base unit yet, so as not to block activation during a test call. Do not turn on yet.

### Commissioning:

- If you program the parameters directly on the SIM by storing the numbers in any mobile phone, insert the SIM into this phone and program.
- Turn off the PIN on the SIM or set the PIN to 0000 (see chapter SIM PIN). Insert the programmed (see previous point) or unprogrammed SIM into the hole in the device (see figure) and press it to secure.

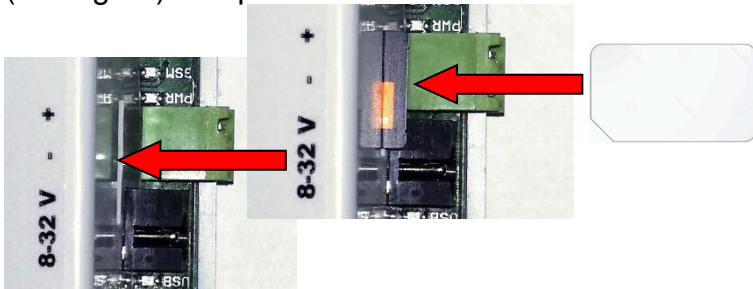

- If you have a backup battery, leave the switch in the lower position (off).
- Connect the power.
- The blue power LED (PWR) lights up, the BAT LED flashes or is lit (see below), the red LEDs on the speaker module (ReMic) are lit.
- Within about 2 seconds, the yellow GSM LED lights up.

- Within about 5 seconds, a trill will sound from the ReMic speaker
- Within about 25 seconds, the yellow LED (GSM) will flash and the tones from the ReMic speaker will be heard.
- Within about 1 minute (depending on the GSM network status) the message "Device in standby mode" is heard, the yellow LED (GSM) starts flashing according to the GSM signal strength (1-5 flashes/double flashes – 2G/4G, see the table at the end of the manual) and if the "running" relay mode is set, the relay is switched on (the green REL LED lights up).
- If you are programming the device with a computer, connect the USB cable and program it according to the instructions in the appropriate chapter.
- If you are programming the device via SMS and no TESTx number is stored on the SIM (x is number 1-8): Send an SMS "INIT TEST1 xxxxxxxx" (xxxxxxx is the number from which you will program the GLWV) to the SIM number entered in the GLWV. Wait for a response ("OK").
- If you are programming the device via SMS and a TESTx number is already stored on the SIM (x is number 1-8): For further programming, use sending SMS from the TESTx number. SMS will not be accepted from other numbers. Send an SMS "WRITE MASTER1 yyyyyy" (yyyyyy is the number that GLWV will call when the button is pressed). Alternatively, other setting SMS (see the table in the relevant chapter) **ATTENTION! If you use the same numbers for TESTx and MASTERx, you must first save all TESTx numbers on the SIM! Only then the MASTERx numbers!** Press the emergency communication button (calls must not be blocked – see the emergency call blocking input): When the button is pressed, the red "ARM" LED on the GLWV lights up and the red LED on the ReMic goes out. When pressed for the time set to activate the emergency call, the tone of the pressed button sounds, the yellow "activation" LED (ACT) lights up, the I1 port on the ReMic is switched on



and the message "Please wait for connection" is played. A number stored as MASTER1 is dialed. GSM network signals can be heard in the speaker (counterpart station search, ringing signal, etc.). After picking up the call on the ringing mobile phone, a connection is established with the elevator cabin. The green "connect" (CON) LED lights up and the message "Elevator Emergency Communicator" is played. **ATTENTION! The message is heard only on the called party!** Terminals I1 and I2 behave according to the ReMic type used (see table above).

- You can adjust the playback volume using the knob on the GLWV (thin screwdriver!). With the setup program or SMS, you can adjust both the volume of reproduction and the sensitivity of the microphone (usually no manipulation is required). If the volume is too high, various acoustic feedbacks may occur due to the acoustic characteristics of the cabin and the way the speaker module is installed. In this case, lower the reproduction volume or microphone sensitivity.
- End the call on your mobile phone to terminate the GLWV connection. The I2(I1) indicator terminals are disconnected, the green "connect" (CON) LED goes off on the GLWV and the message "Call is closed" is played.
- Call the device from one of the MASTERx phones. Your call will be accepted. End the call to cancel the connection with GLWV.
- Try switching relay contacts.
- Connect data inputs and other cabling that has not yet been connected during installation (for easier commissioning) and test the complete functionality of the device.
- If you are using a built-in backup battery, connect it to the system by moving its switch to the upper position (see the Backup battery section).

## **Possible commissioning problems**

None of the lights are on.

Error in the power supply. Check the power connection and polarity.

The blue LED (PWR) lights up, the yellow LED (GSM) flashes, the message "No SIM card inserted" is heard.

The SIM card is not inserted (or inserted incorrectly).

The blue LED (PWR) lights up, the yellow LED (GSM) flashes, the message "Error" sounds, the yellow LED (GSM) lights up permanently.

The GLWV is not able to read the inserted SIM card. It is likely that a PIN is enabled on the SIM if it is not "0000" or does not correspond to the unique PIN of the device (see chapter SIM PIN)

The blue LED (PWR) lights up, the yellow LED (GSM) flashes, the message "Not logged into the network" is heard, which is repeated periodically.

GLWV cannot log in to the network. Either the antenna is not connected or the signal is too weak

The blue LED (PWR) is on, the yellow LED flashes according to the signal strength, the message "Device in standby mode" has been played. When the button is pressed, the red LED (ARM) lights up, you hear the message "Error. The number for MASTER1 is not saved.", no phone number is dialed.

The SIM card does not contain the number MASTER1 or the wrong name is stored (MASTER 1, master1 MASTER1/1, etc.)

The blue LED (PWR) is on, the yellow LED flashes according to the signal strength, the message "Device in standby mode" has been played, the red LED (ARM) is permanently lit, nothing happens after pressing the button.

Shorted or incorrectly connected (switched) pin M in the connection of the cable to ReMic (SRGM).

Growling is heard in the conversation.

Insufficient filtration of the supply voltage or alternating voltage is used.

Penetration of GSM signal into the colloquial path (see. Installation).

Any of the wires (except the power supply) is grounded or connected to the ground.

Various acoustic feedbacks (whistling, echoes, etc.) are heard in the conversation.

Too much amplification throughout the system (mobile phone microphone – cab speaker – acoustic characteristics of the cabin – cabin microphone – mobile phone handset). In most cases, it is necessary to lower the volume of reproduction. Better damping of the elevator (carpeted walls) also helps. Other acoustic features also have an empty cabin and a cabin with people.

Little is heard from the cabin.

Incorrectly positioned microphone (must be located directly behind the hole in the panel) or reduced microphone gain (see. Installation).

## System programming

System parameters can be programmed in 3 ways:

1. By storing the appropriate numbers (MASTERx or TESTx, or PARGLWV and PARRL1) on the SIM card of the device in a suitable mobile phone.
2. Remotely via SMS messages. The number from which we send the SMS as any TESTx (x is number 1 to 8) must already be programmed on the SIM card in the device. The first TESTx number can also be saved remotely from any number using the initialization SMS "INIT TESTx yyyyyyyyyyyyyyy ATTENTION! If a TESTx number already exists on the SIM, the initialization SMS will be ignored.
3. From a PC using the GLWVset program (see the corresponding chapter) via USB.

The SIM card stores all the numbers that the device uses. The numbers that the device calls when the button is pressed are stored under the names MASTER1 to MASTER7 or TEST1 to TEST8. Furthermore, the PARGLWV and PARRL1 numbers are stored here, where all device parameters are stored (except SMS texts and voice messages).

- The digit after the name MASTER (TEST) determines the order in which the numbers will be called. Of course, store only as much MASTERx (TESTx) as you need (even just MASTER1). **Attention! All letters must be capitalized! There must BE NO space between the name and the order number! Phone numbers must be stored in an international format (e.g. +420123456789).**
- If the sequence in the row of names is interrupted (e.g. MASTER1, MASTER2, MASTER4), the system gradually dials the numbers until the space in the series (here MASTER1 and MASTER2), then it ends. Numbers stored in a row after and before a space are valid as authorized numbers for callback (MASTER) and programming (TEST). The line after the space, i.e. the numbers that the system

does not dial, can also be multiple (on the SIM it can be for example 6 numbers under the names MASTER4). The number of numbers that can be used as authorized for callback or programming is basically determined only by the capacity of the SIM card.

## Programming SIM on a mobile phone

- Insert the SIM card into the mobile phone with which you will program the SIM card.
- Turn off the PIN or set the PIN to 0000 (see SIM PIN)
- In the phone book on the SIM card, save the phone numbers to be called (in international form!) under the names MASTER1, MASTER2,... , or TEST1, TEST2...  
**ATTENTION: TESTx numbers must first be stored on the SIM!**
- If you need to change the parameter settings against the default ones, save the numbers with the names PARGLWV and PARRL1, for sending SMS from IN1 input of the name PORTCLOSE or PORTOPEN.
- If SMS messages are stored on the SIM card, delete them.
- Turn off your phone and remove the SIM card

### Note:

- When working with a mobile phone, follow the instructions for the mobile phone type.
- If you are not sure how to write the parameters, do not store these numbers on the SIM. If GLWV does not find SIM numbers, it creates them with default parameters. If you switch off the GLWV after commissioning, you will find both names (PARGLWV and PARRL1) with parameters on the SIM. Now you can only adjust the given parameter as needed – you do not have to count individual places in the number.

## The meaning of numbers and names stored on the SIM card

name	activity
MASTER1	- the first number to which GLWV calls after the emergency call is activated. <b>If the GLWV is to have an emergency call function from the lift, this number must be stored on the SIM.</b> - calls are automatically received from the number
MASTER2	- when the number is saved, GLWV calls this number if the number under MASTER1 is unavailable, occupied, does not answer the call for a long time - calls are automatically received from the number
MASTER3	- when the number is saved, GLWV calls this number if the number under MASTER2 is unavailable, occupied, does not answer the call for a long time - calls are automatically received from the number
MASTER4	- when the number is saved, GLWV calls this number if the number under MASTER3 is unavailable, occupied, does not answer the call for a long time - calls are automatically received from the number
MASTER5	- when the number is saved, GLWV calls this number if the number under MASTER4 is unavailable, occupied, does not answer the call for a long time - calls are automatically received from the number
MASTER6	- when the number is saved, GLWV calls this number if the number under MASTER5 is unavailable, occupied, does not answer the call for a long time - calls are automatically received from the number
MASTER7	- when the number is saved, GLWV calls this number if the number under MASTER6 is unavailable, occupied, does not answer the call for a long time - calls are automatically received from the number
TEST1	- the first number GLWV calls after activating the test function (test call once in a set number of days). If the number is not <b>saved, the function is not activated.</b> - calls are automatically received from the number - SMS messages are received from the number for setting parameters
TEST2	- when the number is saved, GLWV calls this number if the number under TEST1 is unreachable, occupied, does not answer the call for a long time - calls are automatically received from the number

	<ul style="list-style-type: none"> <li>- SMS messages are received from the number for setting parameters</li> </ul>
TEST3	<ul style="list-style-type: none"> <li>- when the number is saved, GLWV calls this number if the number under TEST2 is unreachable, occupied, does not answer the call for a long time</li> <li>- calls are automatically received from the number</li> <li>- SMS messages are received from the number for setting parameters</li> </ul>
TEST4	<ul style="list-style-type: none"> <li>- when the number is saved, GLWV calls this number if the number under TEST3 is unavailable, occupied, does not answer the call for a long time</li> <li>- calls are automatically received from the number</li> <li>- SMS messages are received from the number for setting parameters</li> </ul>
TEST5	<ul style="list-style-type: none"> <li>- when the number is saved, GLWV calls this number, if the number under TEST4 is unreachable, occupied, does not answer the call for a long time</li> <li>- calls are automatically received from the number</li> <li>- SMS messages are received from the number for setting parameters</li> </ul>
TEST6	<ul style="list-style-type: none"> <li>- when the number is saved, GLWV calls this number if the number under TEST5 is unreachable, occupied, does not answer the call for a long time</li> <li>- calls are automatically received from the number</li> <li>- SMS messages are received from the number for setting parameters</li> </ul>
TEST7	<ul style="list-style-type: none"> <li>- when the number is saved, GLWV calls this number if the number under TEST6 is unreachable, occupied, does not answer the call for a long time</li> <li>- calls are automatically received from the number</li> <li>- SMS messages are received from the number for setting parameters</li> </ul>
TEST8	<ul style="list-style-type: none"> <li>- when the number is saved, GLWV calls this number if the number under TEST7 is unavailable, occupied, does not answer the call for a long time</li> <li>- when the number is saved, GLWV sends an information SMS to this number (see the chapter on information SMS): 'Power LOW', 'Power OK' "Low Voltage" 'Button blocked' Information from the operator</li> <li>- calls are automatically received from the number</li> </ul>

	- SMS messages are received from the number for setting parameters
PORTCLOSE	- SMS is sent to the number: 'PORT CLOSE' when port IN1 is closed against ground 'Reset last Emergency Call' when N1 is activated in "Emergency alarm" mode 'SERVICE' when port N1 is switched on in 'service' mode
PORTOPEN	- SMS - 'PORT OPEN' is sent to the number when the IN1 port is disconnected
VOLTAGE	- voltage limit. If it drops below this value, a low-voltage SMS is sent. AA*B (not set by default – voltage is not monitored) AA – volts [01-24] B – tenths of volts [0-9]
VER	- version of fw in GLWV – <b>informational only – do not edit!</b>
SERVICES	- date of the last service intervention and number of interventions ("OK service" mode) - <b>informative only - do not edit!</b>
PARGLWV	- GLWV parameters A#B#C#D#E#F#GG#H#I#J (default '4#4#3#0#1#5#60#3#2#1') A – microphone sensitivity [1-7] B – speaker volume [1-7] C – activation period of TEST functions [0-9] days: 0 - function disabled D – shift of the start of TESTS from midnight [0-9] hours x2 (9=18 h) E – types of tests performed 0 – no test 1 – test call to TESTx numbers 2 – SMS TEST (STATUS) 4 – acoustic path test all bit combinations possible: e.g. 7 - all tests enabled, 6 - SMS and acoustic path test F – IN2 port switching time required to start locking [0-9] s GG – blocking duration after disconnecting the IN2 port [00-99] s H – length of the call button pressed [0-9] s I – waiting time for connection before dialing the next number in the order [1-9] x 10 s J – [0,1] Emergency alarm mode 0 - off 1 - on
PARRL1	- parameters for relays A#B#CC#D (default 5#0#03#1)



	<p>A — [5] — reserve to be filled in with number 5</p> <p>B — relay mode:</p> <ul style="list-style-type: none"> <li>0 — SMS mode, SMS control</li> <li>1 — ECALL mode (relay closed for "emergency" period)</li> <li>2 — camera mode (switches on by picking up, opens the suspension)</li> <li>3 — lighting mode (switches on by picking up, remains closed for the "switching time" after hanging up)</li> <li>4 — button mode, activates to "switching time" after pressing the button</li> <li>5 — "service" mode — after short circuit to IN1 as mode 4 + sends SMS "SERVICE" to the PORTCLOSE number</li> <li>6 — "running" mode — relay closed when GLWV is in operation (voltage, network login)</li> </ul> <p>CC — switching time [00-99] s</p> <p>D — [1] — reserve to be filled in with number 1</p>
--	--

## Remote control and setup via SMS

Only SMS messages sent from numbers registered on the device's SIM card as TEST1 to TEST8 are accepted. SMS messages from other numbers are accepted, but they are ignored and deleted immediately.

**ATTENTION! If you use the SMS to delete numbers, at least 1 TESTx number must remain in the system – otherwise it is no longer possible to program remotely – you will need to use the INIT command again (see above).**

SMS messages are always **WRITTEN IN LARGE LETTERS.**

The body of the SMS is composed of words, separated by spaces. The first word always expresses what will be done:

READ – read (name/phone number or parameter)

CLR – delete (name/phone number)

INIT – initialize

SET – set (relay)

RESET – reset

WRITE – write

**CAL – call AT command **Attention! Commands can render the entire system inoperable!****

The gap is then followed by one or more words specifying what the command refers to (words are again separated by spaces).

E.g:

READ PAR – reading parameters

SET REL1 ON – switching on the relay

If a numeric parameter is programmed, its value is given after the colon ":". If the parameter is multi-digit, both places must always be indicated. E.g:

WRITE PAR TPERIOD:3

WRITE PAR BLOCK:09

GLWV sends back an SMS where the entered command is copied at the beginning. This is followed by a colon followed by the result of the command (e.g. OK when writing the name and phone number)

**SMS command table**

Command (SMS)	Function	Def.
READ ARTICLE	Reading the status of GLWV (version, time, temperature ... see Status Information.)	
READ PAR	Read all parameters	
READ NAME	Read the phone number for NAME	
READ ATEST	Last measured values in ATEST	
READ REL1	Relay status ON/OFF	
READ TEST	Activation <b>time</b> and TEST service call result	
READ IMEI	IMEI number for approximate calculation of the delay of the start of the TEST service call	
READ LOGCALL	List of the 10 last call attempts (date, time, phone number, success rate)	
CLR NAME	Delete a phone number for a NAME	

<b>CLR PARS</b>	Deleting all parameters (factory setting) – saved phone numbers are retained (MASTERx, TESTx)	
<b>INIT TEST1 +420cc... c</b>	Initialization – first GLWV setting – the parameters can be programmed from the number TEST1 +420cc.. c	
<b>SET REL1 ON</b>	Switching on relay 1	
<b>SET REL1 OFF</b>	Switching off relay 1	
<b>SET REL1 ON xx</b>	Switching on relay1 for xx minutes (xx=00–99)	
<b>ECALL RESET</b>	Emergency Call Status Reset	
<b>RESET DEV</b>	Restart your device	
<b>START ECALL</b>	Starts the complete action as after the emergency call was activated. (including EMERGENCY!)	
<b>START TEST</b>	Initiates a complete test action (including, <b>for example</b> , the acoustic path if set)	
<b>START ACALIB</b>	Starts calibrating acoustic path measurements	
<b>WRITE NAME +420cc... c</b>	entry of the phone number for the NAME	
<b>WRITE PAR VOLIN:x</b>	Write down microphone volume settings [x=1-7]	4
<b>WRITE PAR VOLOUT:x</b>	Write down speaker volume settings [x=1-7]	4
<b>WRITE PAR TPERIOD:x</b>	period x days of activation of TEST functions [x=0-9] 0 - function disabled	3
<b>WRITE PAR TSHIFT:x</b>	shift of the start of TESTS from midnight [0-9] x2 hours (e.g. 8= offset by 16 hours)	0
<b>WRITE PAR TMODE:x</b>	Types of tests performed x=0 – no test x=1 – test call to TESTx numbers x=2 – SMS TEST (STATUS) x=4 – acoustic path test possible all bit combinations eg. x=7 - all tests enabled x=6 – SMS and acoustic path test	1
<b>WRITE PAR WBLOCK:x</b>	time x sec. switching of the IN2 port necessary to start blocking [x=0-9] s	1
<b>WRITE PAR BLOCK:xx</b>	Duration of blocking xx sec. after disconnecting the port IN2 [xx=00-99] s	01

<b>WRITE PAR ACALL:x</b>	Time x sec. of press of call activation button [x=0-9] s	3
<b>WRITE PAR WCALL:xx</b>	time xx sec. waiting for connection before dialing the next number in the sequence [xx=10,20, 30...90] sec.	20
<b>WRITE PAR EMODE:x</b>	Emergency alarm mode X=0 – Emergency(alarm) mode disabled x=1 - Emergency(alarm) mode set x=2 – service mode enabled	0
<b>WRITE PAR RL1MOD:x</b>	Relay mode x=0 – SMS mode, SMS control x=1 – ECALL mode (relay closed for "emergency") x=2 – camera mode (switches on by picking up, opens by hanging) x=3 – lighting mode (switches on by picking up, remains closed for "switching time" after hanging up) x=4 – button mode, switches to "switching time" after pressing the button x=5 – "service" mode - after short circuit to IN1 as mode 4 + sends SMS "SERVICE" to the PORTCLOSE number x=6 – "running" mode – relay closed when GLWV is in operation (voltage, network login)	0
<b>WRITE PAR RL1TMON:yy</b>	Switching time in sec. [yy=00-99] s	05
<b>WRITE PORTCLOSE +420cc.. c</b>	When grounding IN1 sends an SMS to the number (according to the settings): "PORT CLOSE" 'Reset Last Emergency Call' 'SERVICE'	
<b>WRITE PORTOPEN +420cc.. c</b>	Writing the number for SMS "PORT OPEN" (disconnection of input)	
<b>CAL AT+CSQ</b>	Determining GSM signal strength	

<b>CAL AT+CPBR=x</b>	Find the number stored at position x	
<b>CAL AT+CCLK="&lt;time&gt;"</b>	Setting the time in GLWV to <time> format <time>= yy/MM/dd,hh:mm:ss±zz yy – year (00-99) MM – moon (01-12) DD – day (01-31) hh – clock (00-23) mm – minutes (00 – 59) SS seconds (00 – 59) ±zz – time zone (-47...+48) hours	

**Note:**

If you want to program some GLWV parameters via SMS, we recommend that you first send the command to read the parameters: "READ PAR"

GLWV Response:

READ PAR:  
VOLIN:4  
VOLOUT:4  
TPERIOD:3  
TSHIFT:9  
TMODE:7  
WBLOCK:1  
BLOCK:01  
ACALL:3  
WCALL:30  
EMODE:0  
RL1MOD:0  
RL1TMON:10

Then just edit the received SMS – "READ" to "WRITE", delete the parameters that are not set, modify the necessary values of the remaining parameters and send the modified SMS back as a response. In the reply, the GLWV shall only indicate the parameters that have been amended. Thus, even parameters that have been written syntactically incorrectly will not appear

Example of SMS for setting GLWV parameters:

WRITE PAR:

VOLIN:1

VOLOUT:4

BLOCK:60

RL1MOD: 1

GLWV Response:

WRITE PAR:

VOLIN:1

BLOCK:60

Other examples:

To read the number of service interventions and the date of the last:

READ SERVICES

GLWV Response:

READ SERVICES:14\*09\*23#3

Where 14\*09\*23 is the date 23.9.2014 and 3 is the number of hits

Attempt to switch the relay in the wrong mode (other than the one intended for SMS relay control)

SET REL1 ON

GLWV Response:

SET REL1 ON:ERROR

Listing the status at GLWV:

READ STATUS

GLWV Response:

READ STATUS:

VER: 105

BATTERY: 3960mV

POWER: 15.5V

TIME: "14/09/23,09:21:55"

OPER: T-Mobile

TEMP: 26C

SERV: 14/09/23#126

INP: 0

BLOCK: 0  
REL: OFF  
ECALL: -  
ACOUSTIC: PASS

Writing only one parameter – setting the waiting time for the next number to be dialed to 30 seconds:

WRITE PAR WCALL:30

GLWV Response:

WRITE PAR:

WCALL:30

To list outgoing calls from GLWV:

READ LOGCALL

GLWV Response:

READ LOGCALL:

(22/12/28,09:41) E: 1234567890

(22/12/28,09:41) E: 1234567890 OK

(22/12/29,10:01) T: 9876543210 OK

Where in parentheses is the date with time, E(T) is the type of call (emergency, test), OK connection succeeded. The example shows a series of „E" calls to the same number where the first attempt was unsuccessful.

## Computer programming

1. On your PC, copy the GLWVset program from the CD to the selected directory (e.g. GLWV). **Attention! To work with the 4G version of the device, the program version must be 5.0 and higher!** The program is "portable" – it does not need installation. If necessary, you will add directories with sound files, etc. to the same directory.
2. The GLWV must be in operation (yellow GSM LED flashes according to signal strength, the message "Device in standby mode" has been played")
3. Connect the MiniUSB cable to PC and GLWV – the GLWV must be lit up with a red USB setup LED.
4. The USB driver can be installed automatically on the PC for the first time you use it. Keep your computer connected to the Internet so that the driver can download.
5. Run GLWVset and set the appropriate port.

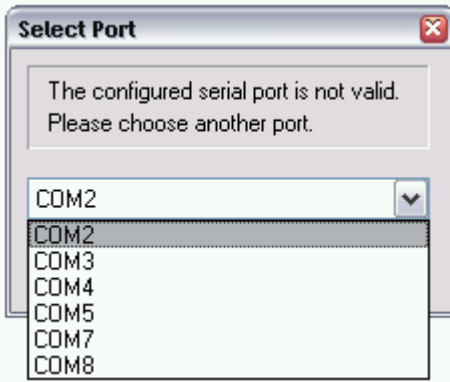

6. The program checks the connection with GLWV. After verifying the connection, it goes into the state corresponding to the GLWV state – in this case, it goes to the "ON" state, where it displays the GSM signal strength and voltage of the motherboard (backup battery). In this state, there is also an interesting "Support" tab, where it is possible to monitor the operation of the device or create "log" files for problem detection.



Note: The appearance of individual program elements is determined by the version of Windows.

# "ON" mode



The "ON" mode is indicated by a lever in the ON position. To program parameters, stop running the GLWV (programming mode) by clicking the button. The program sends a signal to GLWV and waits for a response (displays and bar graph – see figure)

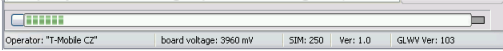

After a while, the GLWV switches – the program responds by moving the lever to the OFF position – program mode. **Do not press to monitor activity! Stop the GLWV!**

In the "ON" mode, some buttons are gray – non-functional (e.g. in the "ON" mode it is not possible to save and load the GLWV settings)

After establishing a connection with GLWV, an indication of the GSM signal size appears

After establishing a connection with the GLWV, the motherboard voltage indicator (backup battery) appears

The green dot indicates the operation on the serial link

After clicking on the "Support" tab, it is possible to monitor the traffic on the GLWV (if the operation is not stopped by the "ON/OFF" button)

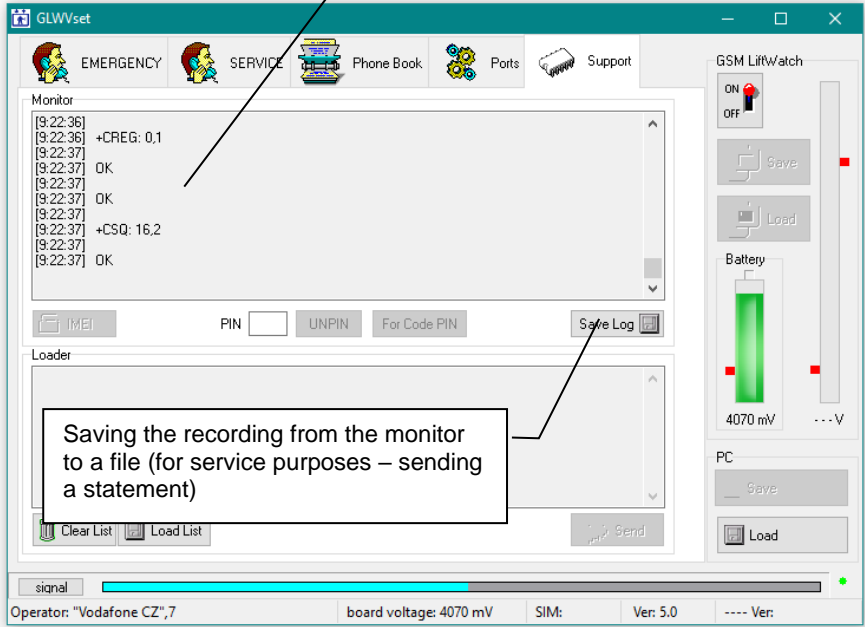

Saving the recording from the monitor to a file (for service purposes – sending a statement)

## Programming mode (OFF position)

GLVV switches to programming mode with the message "Device in programming mode" and a short flashing **yellow** LED (GSM). The program indicates the mode by a lever in the "OFF" position.



## "EMERGENCY" tab

Used to program emergency call parameters

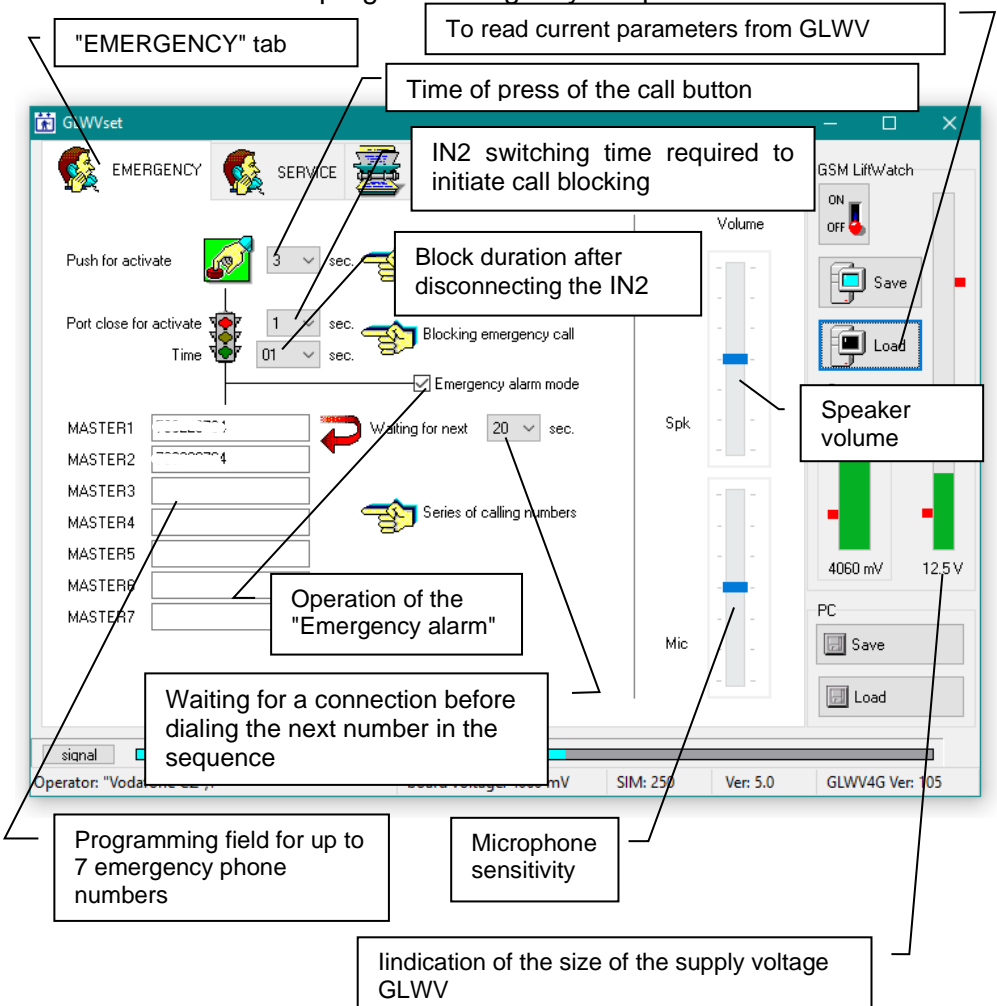

The screenshot shows the "EMERGENCY" tab in the GLVVset software. The interface includes several sections: "Push for activate" with a 3 sec dropdown, "Port close for activate" with a 1 sec dropdown, and "Time" with a 01 sec dropdown. There are also fields for "IN2 switching time required to initiate call blocking", "Block duration after disconnecting the IN2", and "Blocking emergency call". A "Waiting for next" section has a 20 sec dropdown. Below these are seven "MASTER" fields for emergency numbers. On the right, there are volume sliders for "Spk" and "Mic", and a "GSM LiftWatch" indicator. At the bottom, there are "Save" and "Load" buttons for the PC, and a status bar showing "Operator: 'Vodafone', SIM: 250, Ver: 5.0, GLVV4G Ver: 705".

Annotations include:

- "EMERGENCY" tab
- To read current parameters from GLVV
- Time of press of the call button
- IN2 switching time required to initiate call blocking
- Block duration after disconnecting the IN2
- Blocking emergency call
- Emergency alarm mode
- Waiting for next
- Series of calling numbers
- Operation of the "Emergency alarm"
- Waiting for a connection before dialing the next number in the sequence
- Programming field for up to 7 emergency phone numbers
- Microphone sensitivity
- indication of the size of the supply voltage GLVV
- Speaker volume
- 4060 mV
- 12.5 V

# Bookmark "SERVICE"

Used to program parameters for automated testing

The screenshot shows the GLWVset software interface with several callouts:

- TEST function activation period:** Points to the "day(s)" dropdown set to "1" and the "hour(s)" dropdown set to "6".
- Shift of the start of TESTS from midnight:** Points to the "+ Shift" checkbox.
- Set the test type:** Points to the checkboxes for "Test Call", "Test Acoustic path", and "SMS TEST".
- Number for sending status SMS:** Points to the "TEST8" field.
- Waiting for connection before dialing the next number in the sequence taken from EMERGENCY:** Points to the "20 sec." label with a red circular arrow.
- Programming field for up to 7 phone numbers for test calls:** Points to the list of fields labeled TEST1 through TEST7.

The interface includes a menu bar with "EMERGENCY", "SERVICE", "Phone Book", "Ports", and "Support". A "GSM LifWatch" section has "ON" and "OFF" buttons and a "Save" button. A "Battery" section shows two battery levels: 4060 mV and 12.5 V. A "PC" section has "Save" and "Load" buttons. The status bar at the bottom shows "Operator: 'Vodafone CZ',7", "board voltage: 4060 mV", "SIM: 250", "Ver: 5.0", and "GLWV4G Ver: 105".

## Phone Book tab

Phone book of SIM numbers – checking SIM numbers – e.g. operator, service status, etc.

The screenshot displays the 'Phone Book' tab in the GLWVset software. The interface features a menu bar with 'EMERGENCY', 'SERVICE', 'Phone Book', 'Ports', and 'Support'. A table with columns 'Name' and 'Phone' is present. Callouts indicate the 'Name position' and 'Phone number slot'. On the right, there are 'GSM LiftWatch' controls (ON/OFF), 'Save' and 'Load' buttons, and a battery status indicator showing 4060 mV and 12.5 V. Below the battery indicator are 'PC' 'Save' and 'Load' buttons. The bottom status bar shows 'Operator: Vodafone CZ', 'board voltage: 4060 mV', 'SIM: 250', 'Ver: 5.0', and 'GLWV4G Ver: 105'. Callouts also point to 'Add a row above a cursor row', 'Clear cursor line', and 'Search for a name'.

# "Ports" tab

**Mod settings for relay**

**Numbers where SMS will be sent when the IN1 port is switched on and off  
If the number is not filled in, the SMS is not sent**

**Information about the mode that affects the IN1 port usage type (SMS)**

**Boundary voltage for satisfactory/low power decision-making.**

**Items linked to relay switching time**

**Relay actuation time**

The screenshot shows the 'GLWWset' software interface with the 'Ports' tab selected. The 'Relay' section includes radio buttons for 'SMS switch', 'Emergency alarm mode', 'camera', 'running', 'light', 'button', and 'service OK', along with a 'switching time' field set to '03 sec.'. The 'IN1' section has input fields for 'SMS PORTOPEN' and 'SMS PORTCLOSE', a checked 'Emergency alarm mode' checkbox, and an unchecked 'service OK' checkbox. The 'Power supply monitor' section shows a 'Low supply voltage' field set to a blank space followed by a 'V' unit. The status bar at the bottom indicates 'Operator: "Vodafone CZ",7' and 'board voltage: 4060 mV'. On the right side, there are 'Save' and 'Load' buttons for 'PC' and 'Battery' sections, with a battery level indicator showing approximately 4060 mV out of 12.5 V.

## "Support" tab

In the "ON" mode it is designed for traffic monitoring (see the "ON" mode), in the "OFF" mode it is designed for adjusting voice information.

**ATTENTION! Unprofessional use may cause malfunction of the GLWV, for which the manufacturer is not responsible.**

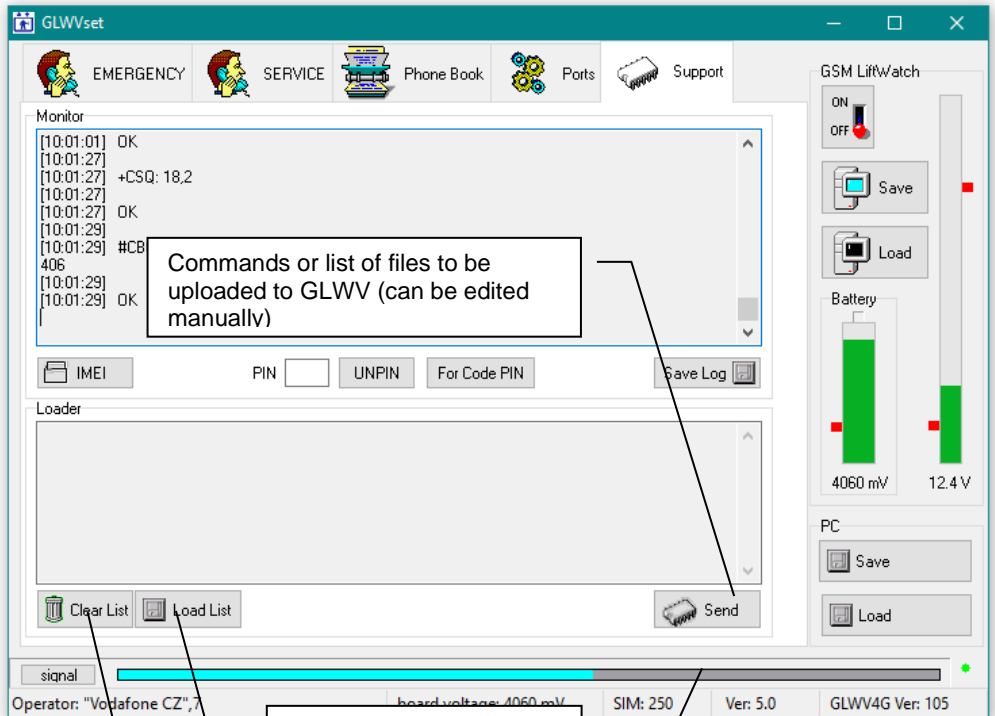

Clear a list

Retrieve a list from a PC

Execute commands and send files to GLWV. The action is again indicated by an increasing strip in the bargraph:

The inset screenshot shows a signal strength indicator with a green bar increasing from left to right, indicating that commands are being executed and files are being sent to GLWV. Below the indicator, the status bar shows: Operator: "T-Mobile CZ", board voltage: 3960 mV, SIM: 250, Ver: 1.0, and GLWV Ver: 103.



## Examples

We recommend copying the sample commands from the CD directory with the setup program.

### Replace voice messages with another language from the sent file.

1. unzip the delivered zip file (together with the directory) to the directory where you have the GLWVset setup program.
2. Click on the "Load List" button (see the previous figure) and in the expanded directory select the file "VoiceMessages.ifo" – a list of audio messages - wav files - will appear that will be uploaded to GLWV (see the previous figure).
3. By clicking on the "Send" button you send the files to the GLWV – the progress is indicated by an increasing column in the bargraph.

Note: If you want to upload the same list again (e.g. after trying and possibly editing one of the files – see below), you do not need to reload the list. Conversely, if you want to upload a different list, you must delete the previous one – the lists are added to each other differently so that multiple actions can be performed simultaneously (see example below)

### Delete the message "Elevator Emergency Communicator."

1. Click on the "Load List" button and select the file "DELMessageECALL.ifo" – script in the command samples.
2. By clicking on the "Send" button you send the command to the GLWV – the progress is indicated by an increasing bar in the bargraph.

Replace voice messages with custom messages, omitting "Elevator Emergency Communicator."

1. extract the VoiceMessages zip file from the samples (together with the directory) to the directory where you have the GLWVset setup program
2. Replace the files with your own (except for the ecall.wav file) in the same format (wav, PCM, 8kHz, mono, 16 bits) – the maximum length of a single file can be 128,000bytes. File names must be preserved.
3. You can delete the ecall.wav file (you don't have to, but it will be unnecessarily uploaded to GLWV)
4. To the directory with modified wav files (and the file "VoiceMessages.ifo") copy another script file - "DELMessageECALL.ifo"
5. Click on the "Load List" button and select the file "VoiceMessages.ifo" in the directory – a list of audio messages - wav files - will appear that will be uploaded to GLWV
6. We still need to ensure deletion of the unnecessary file "ecall.wav" from GLWV: Click on the "Load List" button again and add the file "DELMessageECALL.ifo" – in the dump the list of uploaded wav files is now supplemented with the command to delete the file "ecall.wav"
7. Click the "Send" button to send the files and the delete order to GLWV at once. – progress is indicated by an increasing column in the bargraph.

Identification of the lift in a voice message.

If modern identification using CLIP (caller number), which can be easily processed digitally, is not enough, you can record your voice identification instead of the general message "Elevator Emergency Communicator.", which is played when emergency communication with the dispatching center is established.

1. Copy the contents of the "ident" directory from the samples (files "ecall.wav" and "EcallMessages.ifo") into the selected directory.
2. Create your eCall file here.wav (wav, PCM, 8kHz, mono, 16-bit) with your own identification recording. You can use the existing ecall.wav as a basis.
3. Click on the "Load List" button and select the file "EcallMessages.ifo" in the directory – a list of audio messages will appear (here only one – ecall.wav) that will be uploaded to GLWV
4. By clicking on the "Send" button you send the file to GLWV (overwrite the existing "ecall.wav" with your own file) – the progress is indicated by an increasing column in the bargraph.

## Return from programming mode to standby mode "ON" (GLVV relaunch)

If you have everything you need set up. Save everything with the "Save" button to GLVV.

Restart the GLVV by switching the program to "ON" mode – by clicking on the button. The program sends a signal to the GLVV and waits for a response (displays the Bargraph – see figure)

The program checks the status of the GLVV and signals commissioning by moving the lever to the "ON" position

If you have everything you need from the parameters set (does not apply to the activities on the "Support" tab), **save everything** by pressing the "Save" button to GLVV. The progress of deposition is again signaled by the bargraph – see Fig.

Because all SIM slots are gradually overwritten or deleted, this operation may take longer (depending on the SIM size). The termination of work is always signaled by the disappearance of the bargraph.

In the "OFF" mode, you can re-load all GLVV parameters into the program at any time.

You can also save or upload parameters from a PC

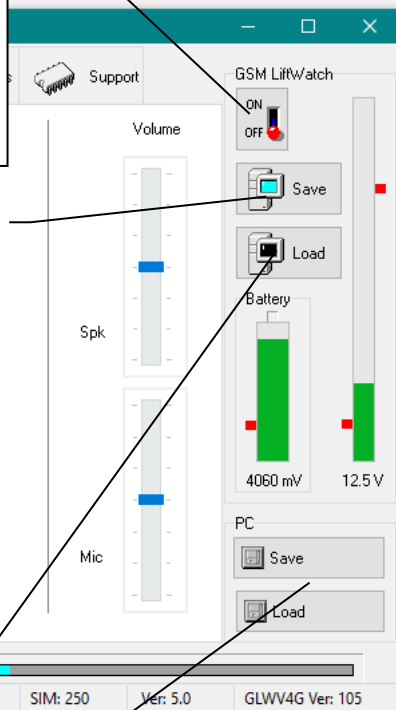

GLVV behaves in the same way after reboot as after switching on the power (LED, voice information)



## **Acoustic path calibration function.**





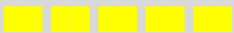

If you want to use the Acoustic path test function (see settings) and you use multiple ReMic connected devices, the device has difficult condition recognition conditions (multiple microphones and speakers are connected). In this case, it is necessary to measure the acoustic path in good condition (with the final ReMic position adjustment and volume adjustment). The instrument stores the measured values as reference values. The device then compares these calibration values with the newly measured series during the acoustic path test. The comparison then evaluates the momentary deviation of the acoustic path parameters.

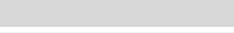
Calibration can be started via SMS "START ACALIB".

If an outgoing call was made just before calibration (e.g., when testing an instrument or device, it performs the Auto Test function), the machine waits about 2 minutes and then performs calibration.







# LED signalling on GLWV4G

Blue LED (PWR)		<b>Continuous light</b> GLWV power is on <b>Continuous light - LED shines dimly</b> GLWV powered by built-in backup battery
		<b>Off</b> GLWV power is off
Yellow LED (GSM)		<b>Continuous light</b> Activation of the GSM module after switching it on
		<b>Flashing with a period of 1 sec.</b> GLWV initialization (login to GSM network, loading parameters from SIM, etc.), preparation of acoustic path test
		<b>1 to 5 short flashes</b> GLWV in standby mode, logged into the 2G network (the number of flashes corresponds to the signal strength)
		<b>1 to 5 short double flashes</b> GLWV in standby mode, logged into the 4G network (the number of flashes corresponds to the signal strength)
		<b>Flickering long light, short gap</b> Call (connection) in progress
		<b>Flickering shorter light, short gap</b> Sending an SMS message
		<b>Short blink every 9 sec.</b> GLWV4G is in programming mode (mode "OFF")
		<b>Fast short flashing</b> The program run in GLWV4G ended (in GLWVset the switch was in the "OFF" position during device start-up)
Green LED (REL)		<b>Continuous light</b> relay closed
		<b>Off</b> relay opened
Green LEDs (IN1, IN2)		<b>Continuous light</b> Port shorted to ground (on port voltage<1V)
		<b>Off</b> Port open (on port voltage>2V)
Yellow LED (ACT)		<b>Continuous light</b> Activation of an emergency call after pressing the button (copies I1 switching on ReMic)
		<b>Alternating flashing of CON/ACT with a period of 1 sec.</b> Negative automatic test result (TESTx connection) - new EN 81-28

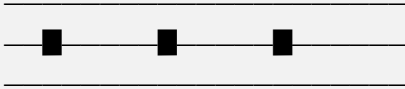
Green LED (CON)		<b>Continuous light</b> Establishing an emergency call with the opposite station (call center)
		<b>Alternating flashing of CON/ACT with a period of 1 sec.</b> Negative automatic test result (TESTx connection) - new EN 81-28
Green LED (BAT)		<b>Flashing with a period of 1 sec.</b> Backup battery not inserted
		<b>Continuous light</b> The backup battery is inserted and ready
Red LED (ARM)		<b>Continuous light (for the duration of pressing the button)</b> Emergency call activation button pressed
		<b>Flashing with a period of 1 sec.</b> Initializing the device
Red LED (USB for the program. )		<b>Continuous light</b> GLWV4G connected by USB cable to PC for programming (parameter setting)

# Tones and voice messages GLWV4G

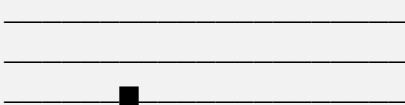
In addition to common tones and GSM communication signals (ringing tone, busy tone, various operator announcements), the GLWV4G has its own activity signaling.

	<p><b>Repeated mid-pitch tone</b> start (restart) GLWV</p>
	<p><b>Mid-pitch tone</b> GLWV accepted pressing the button for an emergency call (the button must be pressed for a certain time - see settings)</p>
	<p><b>High note, once after dialing number</b> GLWV received a response from the GSM network when establishing a connection (e.g. establishing a connection with the opposite station - the tone depends on the operator)</p>
	<p><b>Lower tone, higher tone – can be multiple times</b> logging into the GSM network</p>
	<p><b>Low tone - error</b> GLWV detected an error (e.g. low power, no response of the GSM module to the command, etc.). GLWV may respond by restarting the device.</p>
	<p><b>Beep lower tone, higher tone with increasing number of beeps.</b> GLWV detected disconnection from the GSM network (weak signal, disconnected antenna...)</p>
<p>Voice message ready.wav: <b>"Device in standby mode"</b></p>	<p>GLWV after start (restart) is ready for operation - logged into the GSM network</p>
<p>Voice message stop.wav: <b>"Device in programming mode"</b></p>	<p>The GLWV has been switched to parameter programming mode by the GLWVset program.</p>
<p>Voice message atest.wav: <b>"Sound check: 1, 2, 3, 4. End."</b></p>	<p>GLWV tests the local audio path (GLWV - cable to ReMic - speaker - microphone - cable back to GLWV). We do not recommend changing the message. It is tuned for the audio path test.</p>



Voice message block.wav: <b>"The emergency call is still blocked. Please try in a moment."</b>	Voice message when pressing the emergency call button and call blocking by activating the IN2 port.
Voice message ecall.wav: <b>"Elevator emergency communicator."</b>	A voice message when emergency connection with the opposite station (call center) is established (pickup) - can only be heard on the called party (call center).
Voice message endcall.wav: <b>" The call is ended."</b>	Voice message after the connection is terminated.
Voice message error .wav: <b>"Error."</b>	Voice message when there is a system error. GLWV may respond by restarting the device.
Voice message nocall.wav: <b>"The connection failed. Please try again in a moment."</b>	A voice message if a connection cannot be established with any of the phone numbers programmed in the MASTERx series.
Voice message nolog.wav: <b>"Not logged into the GSM network."</b>	GLWV cannot log into the GSM network. Probably the antenna is not connected or the GSM signal is very weak.
Voice message nosim.wav: <b>"No SIM card inserted."</b>	GLWV does not detect (read) the SIM card. Either the SIM is not inserted at all or it is inserted incorrectly.
Voice message pin.wav: <b>"Bad PIN."</b>	Voice message after start-up in case of inserting a SIM with an activated PIN other than 0000 or a PIN corresponding to the unique number of the GSM module (see chapter SIM PIN).
Voice message test.wav: <b>"Attention, this is a test of connection."</b>	Voice message during a test connection (connections from the TESTx series).
Voice message timeout.wav: <b>"Attention. The call will be terminated."</b>	Voice message before automatically disconnecting (after 5 minutes).
Voice message wait.wav: <b>"Please wait for the connection."</b>	Voice message when emergency call is activated - waiting for connection.

Voice messages are always heard only in ReMic speakers. An exception is the ecall.wav message, which is heard only on the called party.

## GLWV with back-up battery

If you already have a GLWV with a backup battery in the van, check that the battery switch is in the lower position (switched off) before commissioning.

**Do not store the device with the battery inserted unless the battery switch is in the lower position!** Self-discharge may destroy the battery, which is not covered by the manufacturer's warranty.

### Inserting a backup battery:

- Use only manufacturer-approved batteries: Li-Ion 18650, 2000-2600mAh
- Pay attention to polarity. Never insert the battery upside down! The device may be destroyed.

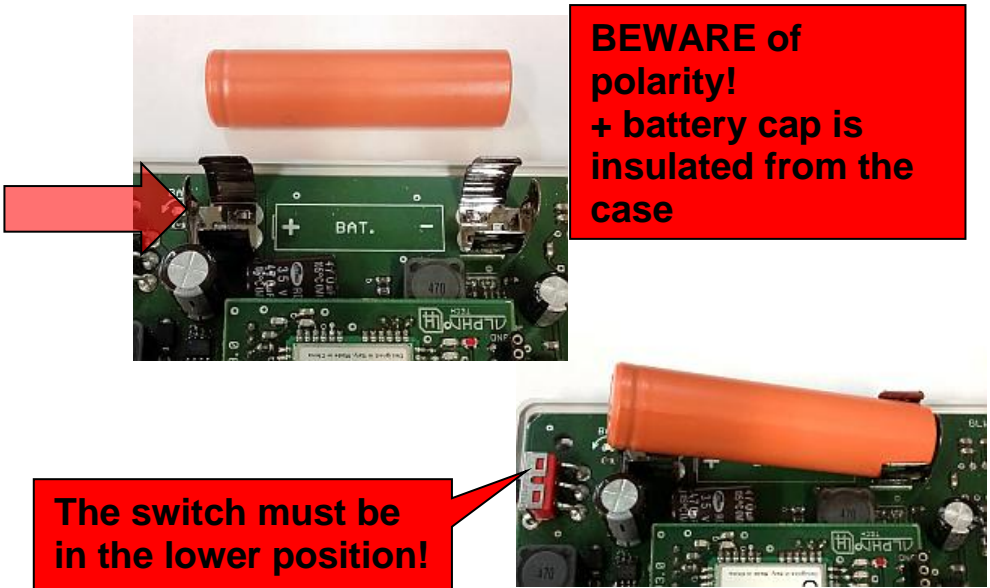

**When the polarity of the battery is rotated, the red LED flashes or lights up.**



If everything is correct, connect the power supply, and then move the switch to the upper position. – Connect the backup battery to the system.

Test the battery backup to function properly by disconnecting the main power supply.

**The manufacturer is not liable for defects caused by non-compliance with the prescribed procedure.**

# The simplest connection with ReMicA1 without optical signaling

Signaling in the cabin only by voice, power supply from the lift system.

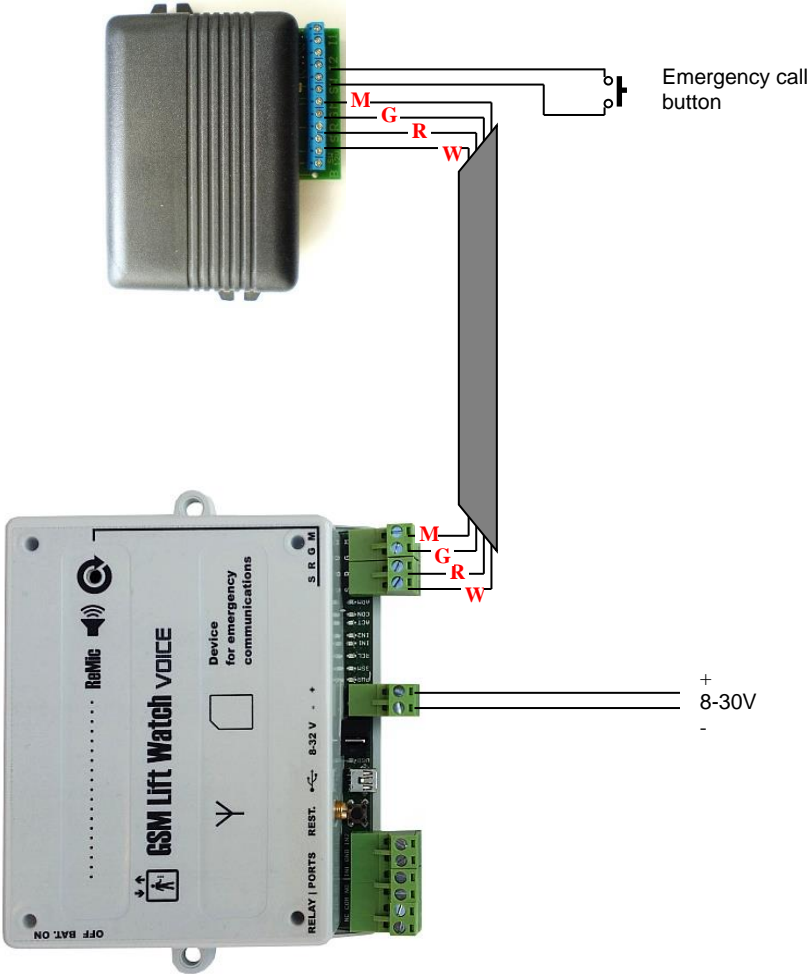

## The simplest connection with ReMicAS1 without optical signaling

Involvement is the same as on the walking page. Since it is completely identical, the other examples that will be for ReMicA1 are also completely valid for ReMicAS1.

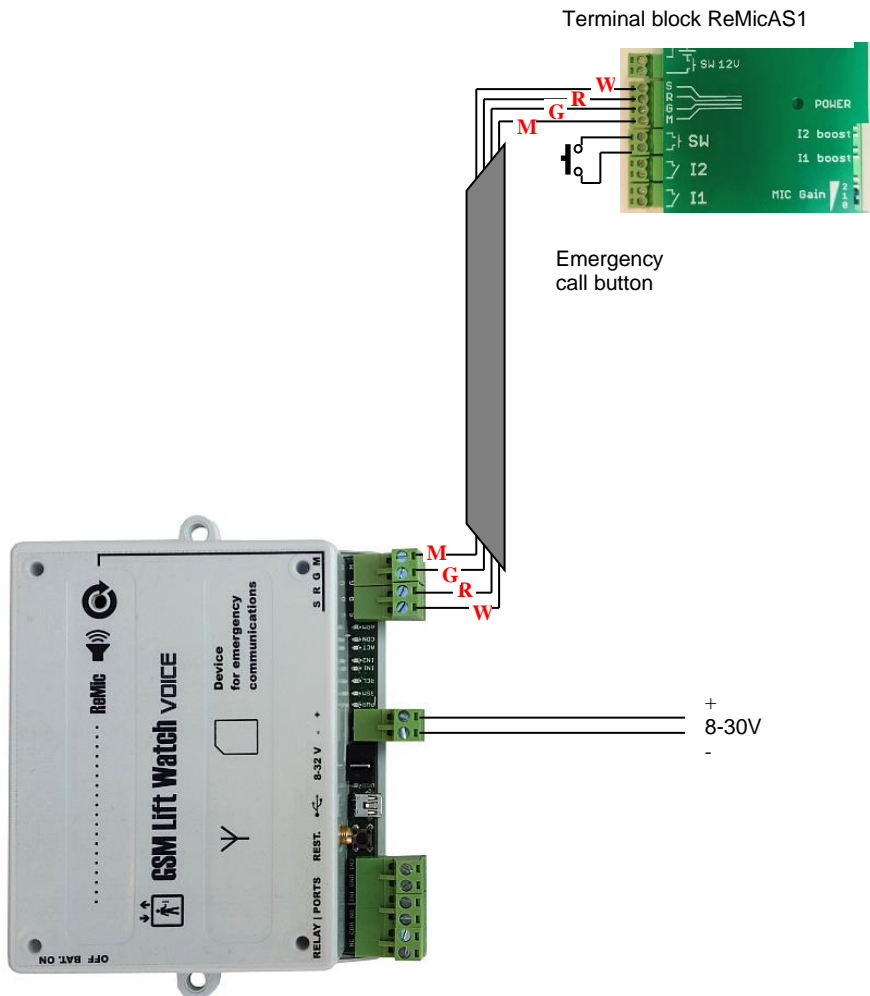

# Basic connection with ReMicA1 and signaling bulbs power supply from the elevator system

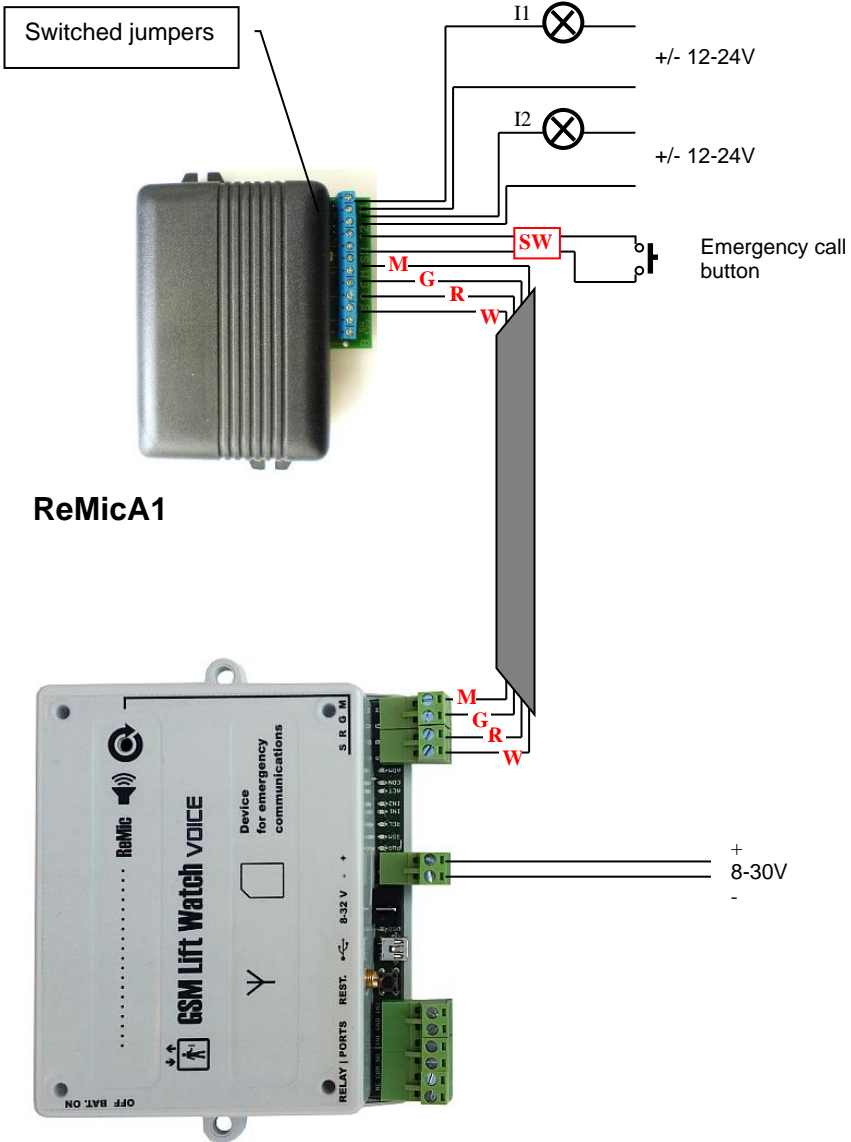

# Basic connection with ReMicA1 and signaling LEDs power supply from the elevator system

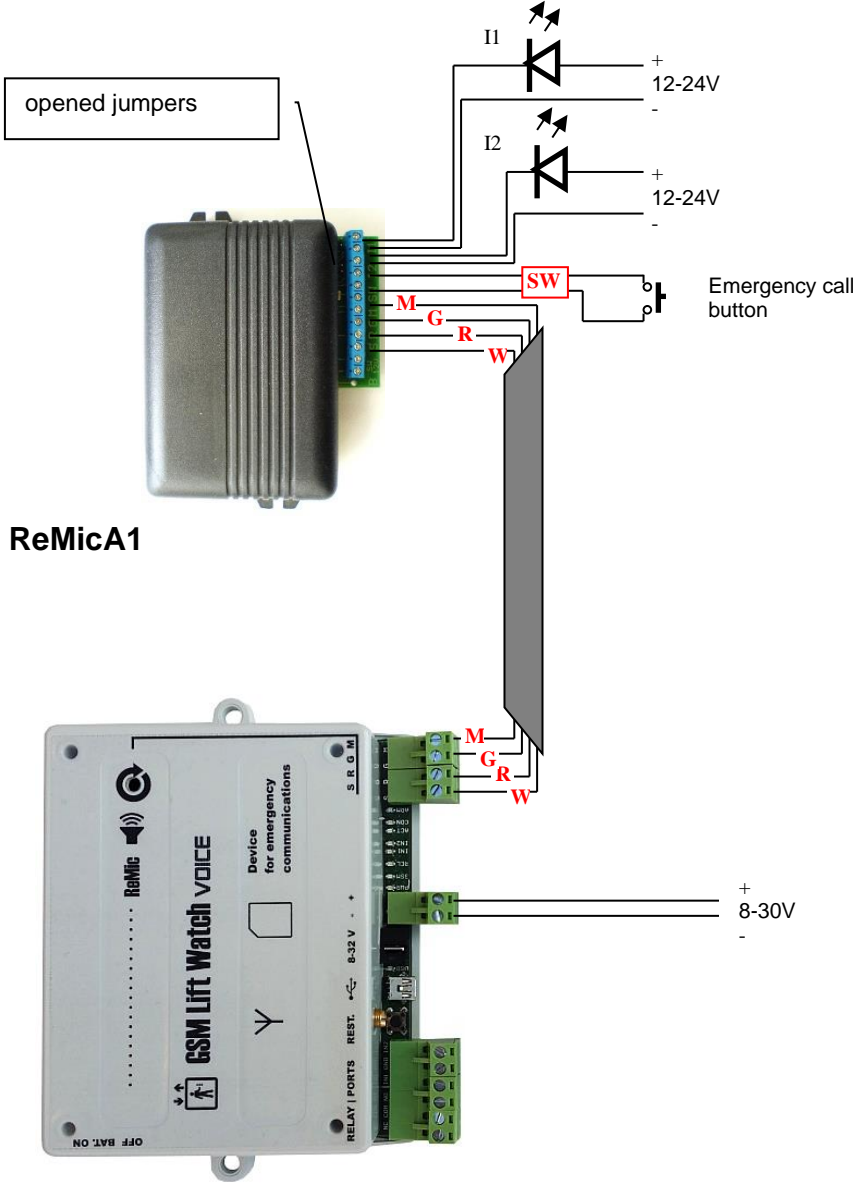

**Basic connection with ReMicA1 and signaling control by logical inputs of the panel in the cabin (against the ground)**

power supply from the elevator system

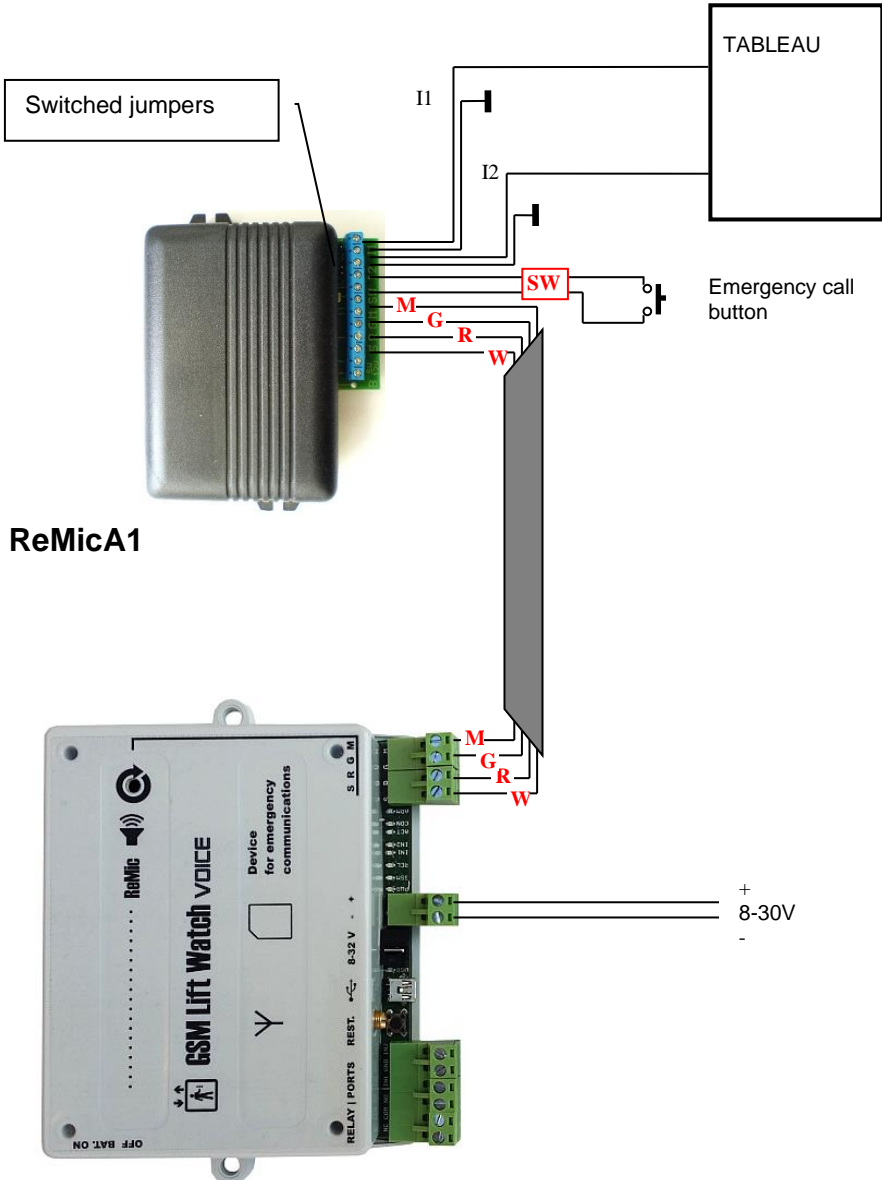



**Basic connection with ReMicL1 and LED signaling**  
 power supply from the elevator system  
 (ReMicL1 is only for direct LED connection)

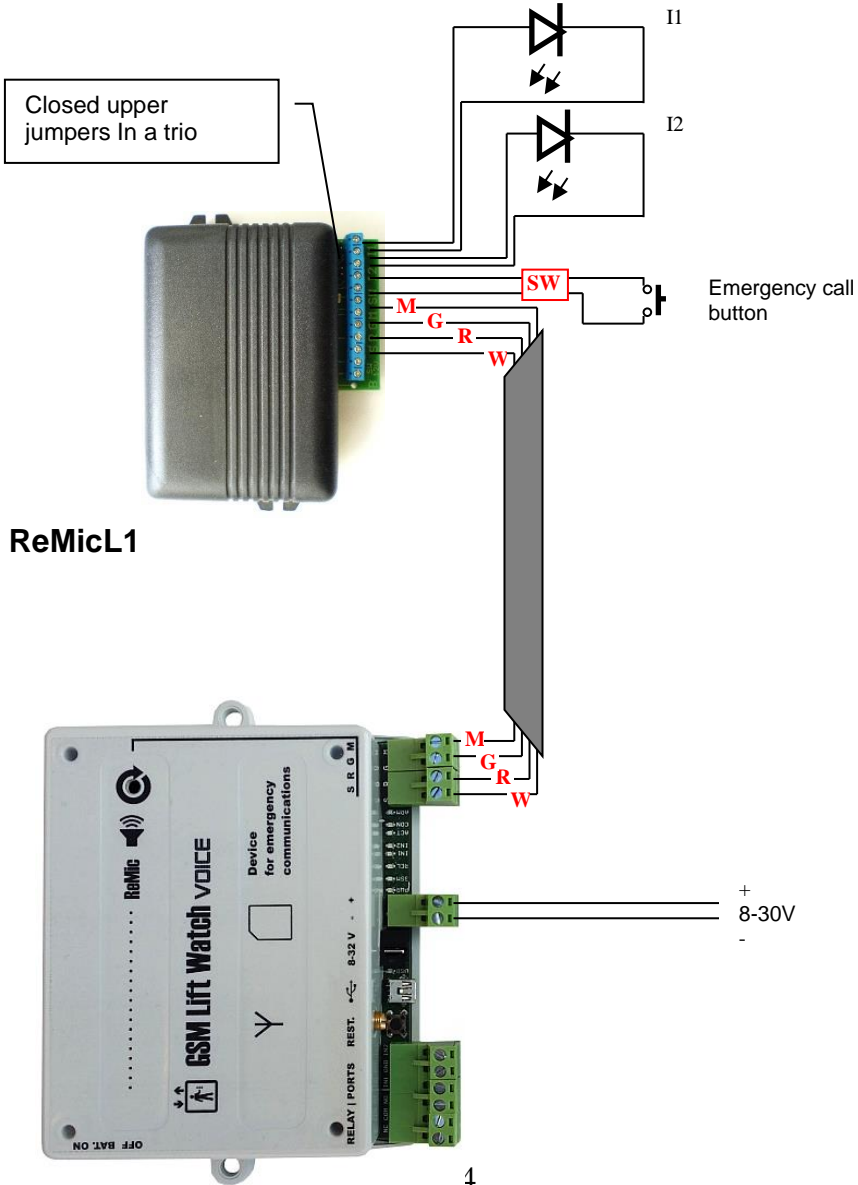

# Basic connection with power from an AC/DC adapter

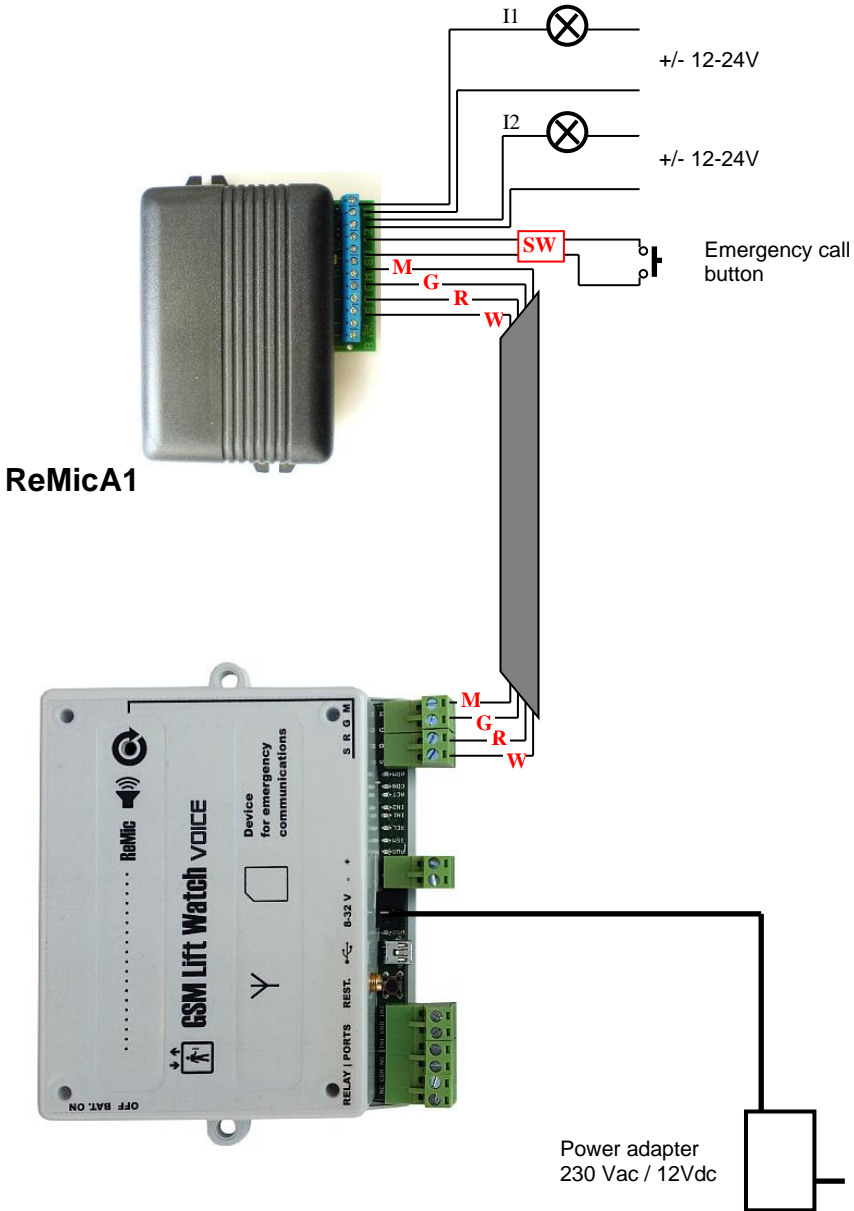

# Example of wiring with external backup battery and charger

(Of course, the device may contain a built-in backup battery.)

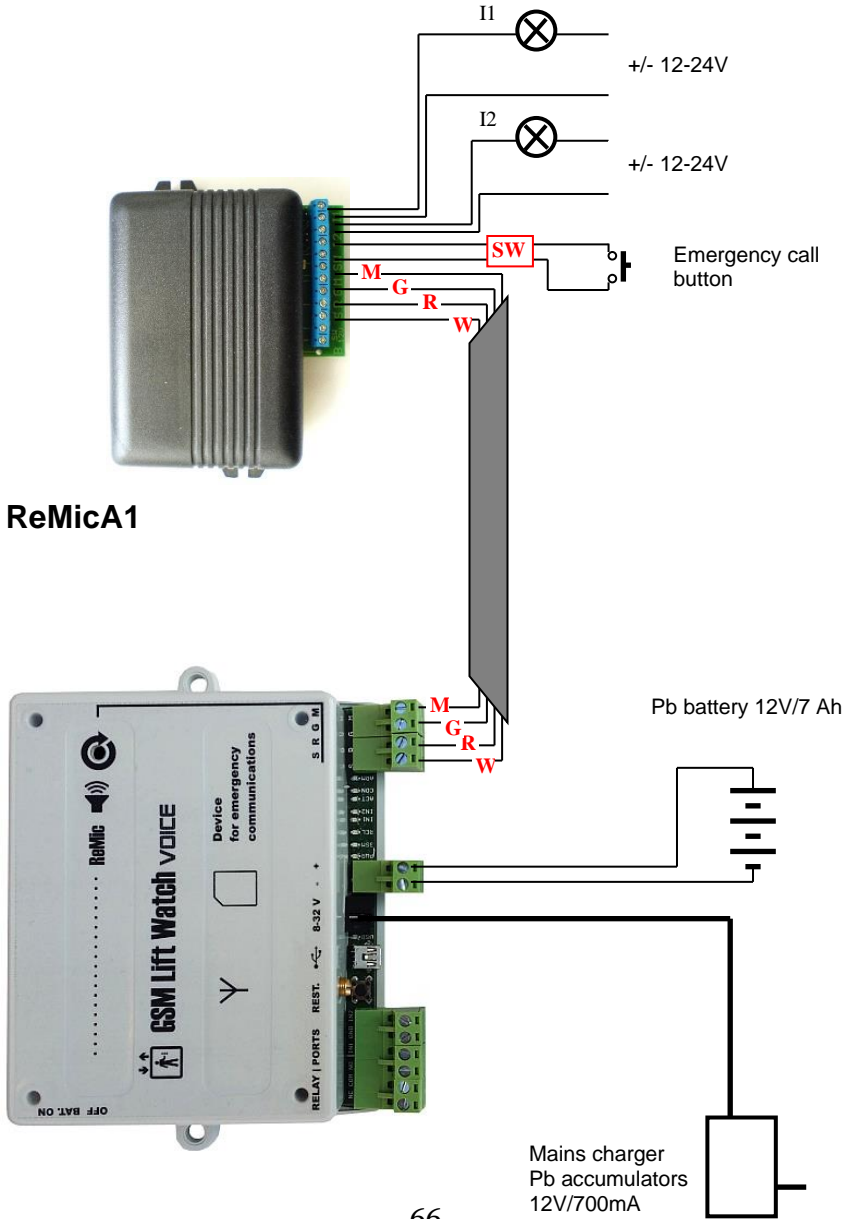

# Example of wiring for communication with the engine room (PREPOJ)

Communication in the cab

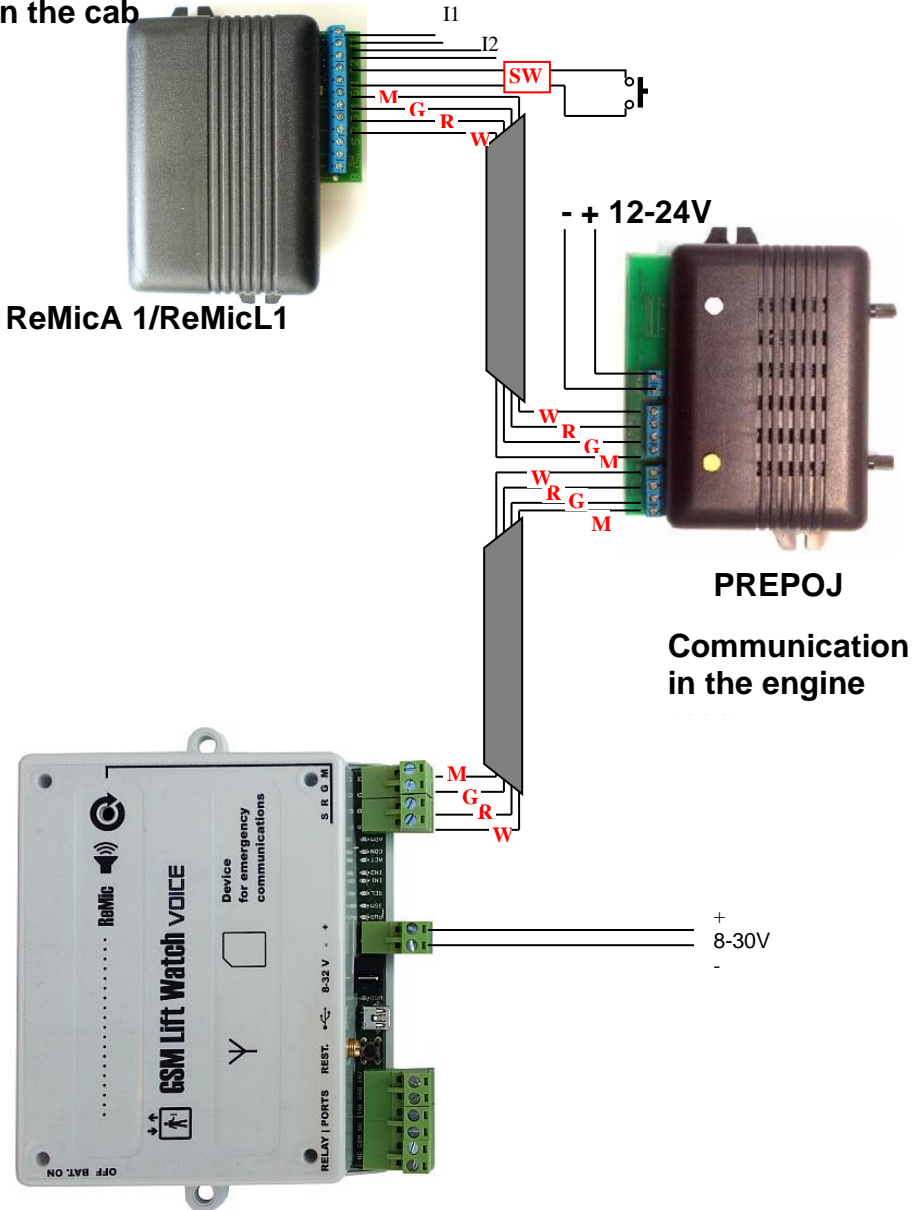

**Example of wiring for communication with cabin, shaft and engine room (together up to 3 ReMics can be connected)**

**Cab communication  
- ReMicA(L)1**

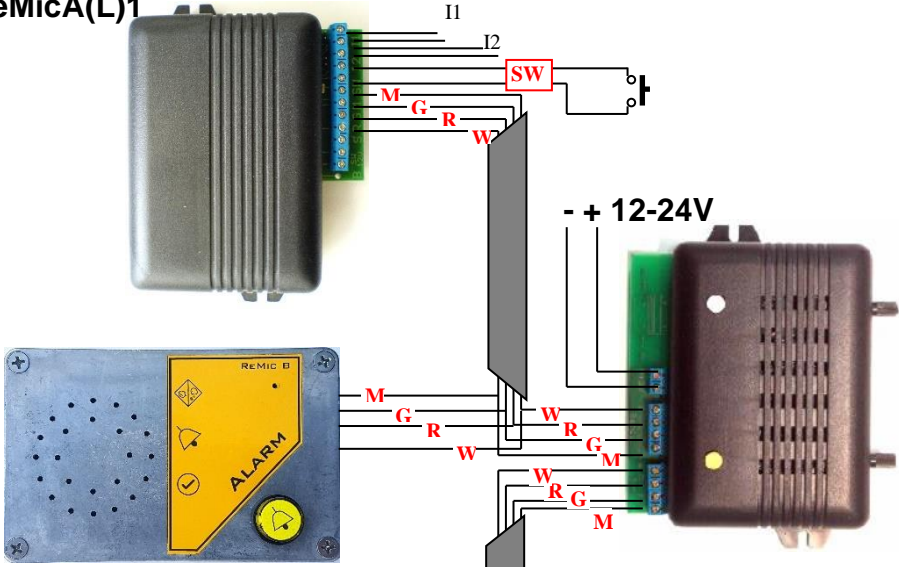

**Communication in the shaft -  
2x ReMicB**

**PREPOJ  
Communication  
in the engine**

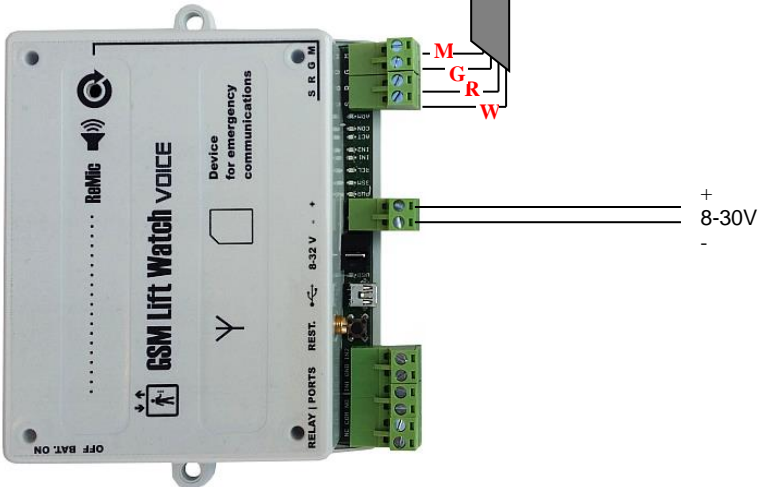

**Example of activation connection using galvanically isolated terminals of the 12 V ReMicA(L)1 switch – connection to a doorbell or siren.**

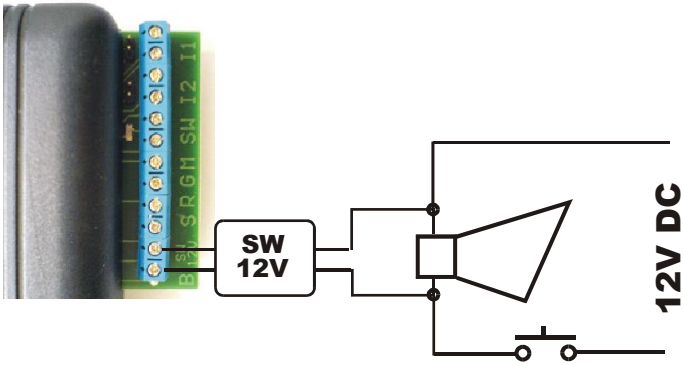

**Example of siren connection to a relay in the "button" mode**  
(Relay closed while the button is pressed)

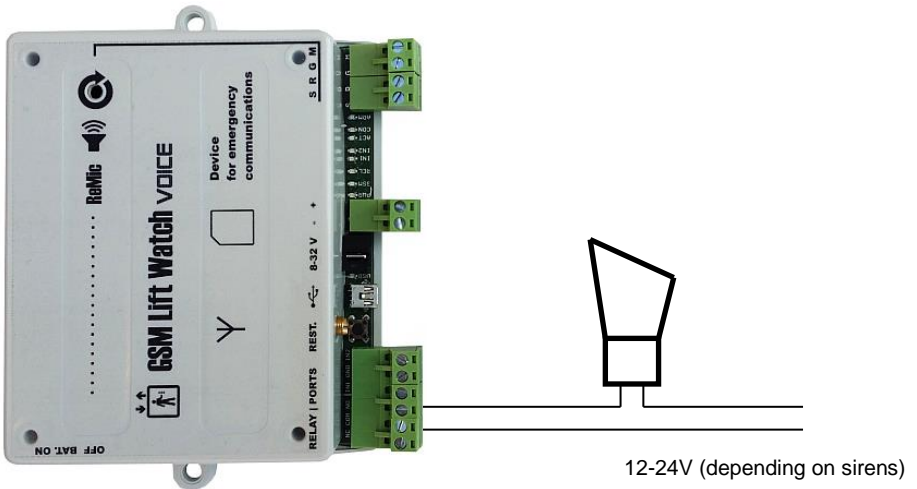

# Example of connection of the "service" button with the "confirmation" indicator light

(The indicator lights up when the GLWV receives pressing the "service" button and sends an SMS)

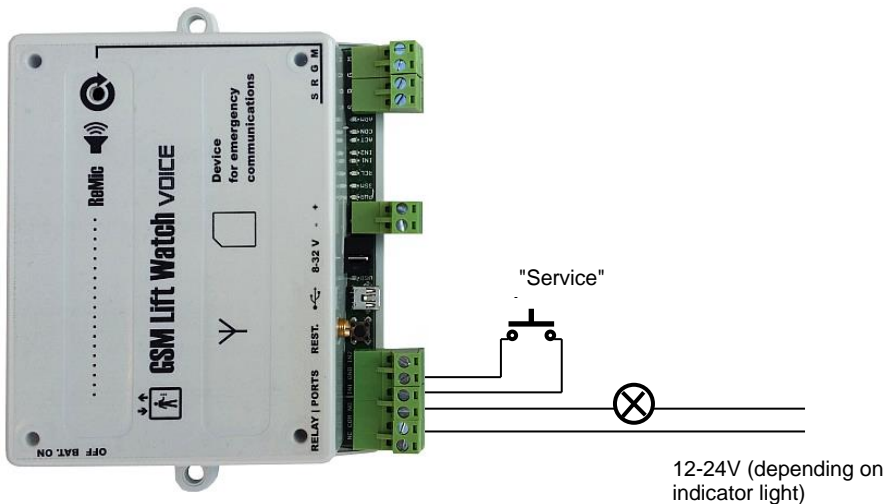

## To install the GLWV4G 4G modem for Windows 10 and 11:

- a) Connect the switched-on GLWV4G (connected to the GSM network) with the PC using the MiniUSB cable. Connect the MiniUSB to the USB 4G modem (see fig. on page 15). The PC must be connected to the Internet. Windows detects the connection of a new USB device and installs basic drivers automatically.
- b) In the bundled CD Find the directory "drivers". Select the appropriate zip file according to Win10 or Win11. Unzip and follow the steps in .pdf File. In the case of Win10, be sure to distinguish whether you are installing drivers for a 63- or 32-bit system. Windows creates (sections Settings, Network and Internet) mobile Internet connection network (if SIM allows). In Device Manager, in the Ports (COM and LPT) section, you can find 3 new serial ports: Calf Serial Diagnostics Interface, Telit NMEA Interface and Calf Serial SAP Interface. In the Modems section, 2 important modem ports will be added Telit LE Family USB modem.
- c) If you wish to use your device for an LTE(4G) Internet connection, select Cellular network in Settings, Network & Internet and set the access point (APN) of your GSM provider.





**ALPHA**  
Tech